

Diagnosis • Monitoring  
Quality Control • R&D

**PD** •  
by Megger®  
Power Diagnostix Systems



Quality Instruments and  
Engineering Services for  
Medium and High Voltage  
Diagnostic Applications

**EN**  
ENGLISH



# Power Diagnostix

## ABOUT POWER DIAGNOSTIX

---

Power Diagnostix Systems GmbH provides quality instruments and engineering services for high voltage diagnostic applications. Power Diagnostix has built a solid reputation since market introduction of our partial discharge detectors in early 1993. Our ICM series of digital partial discharge detectors is used for evaluation of electrical insulation by electric utilities, manufacturers, and research institutes worldwide.

In addition to digital partial discharge detectors and monitoring systems, Power Diagnostix produces instruments for commissioning tests of GIS systems, automated control of high voltage tests, fibre optic connections for analogue signal transmission between instruments and sensors, and for other applications in high voltage. All of our instruments and specialised software products are developed in Aachen, Germany. The company's principal engineers are active in several scientific committees.

In June 2019, Power Diagnostix became a part of the Megger group.

At Power Diagnostix, we understand that keeping the power on is essential for the success of your business. That is why we are dedicated to creating, designing and manufacturing safe, reliable, easy-to-use portable test equipment and professional technical services backed by world-leading support and expertise.

We can assist your acceptance, commissioning and maintenance testing for predictive, diagnostic or routine purposes. By working closely with electrical utilities, standards bodies and technical institutions, we contribute to the dependability and advancement of the electrical supply industry.

Our engineers actively participate in regulars' committees, meetings with all the big trade associations around the world, training organisations and government organisations, to understand the needs of electrical contractors. So, when new legislation or rules are introduced, you can count on Power Diagnostix to put your interests first, because Power Diagnostix products and services help customers all over the world, improving their efficiency, reducing costs, and meeting standards. It operates globally, with dedicated field sales teams and distributors located all over the world.

**Power Diagnostix is certified according to ISO 9001:2015, ISO 14001:2015, and ISO 45001:2018. We offer full service, repair, and calibration service accredited to ISO 17025:2018.**





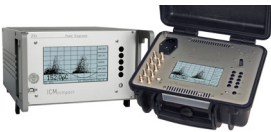

<b>Product selection guide</b>	4	<b>RIV measurement</b>	
<b>Product applications</b>		<i>RIVmeter</i>	30
Transformers	7	<b>Test and automation</b>	
Rotating machines	9	<i>HVcompact</i>	31
Switchgear (GIS/GIL)	11	<i>STEPcompact</i>	32
Cables	13	<i>HVcontrol</i>	33
		<i>HVTC and TCU</i>	34
<b>PD monitoring systems</b>		<b>Special instruments</b>	
<i>ICMmonitor</i>	14	<i>PRPDreplay</i>	36
<i>ICMmonitor Portable</i>	16	<i>ATTanalyzer</i>	37
<i>GISmonitor</i>	17		
<i>GISmonitor Portable</i>	18	<b>Test vans and trucks</b>	
		<i>Mobile HV AC test systems</i>	38
<b>PD measurement devices</b>		<b>PD accessories</b>	
<i>ICMcompact</i>	19	Sensors	39
<i>ICMsystem Generation 5</i>	20	Quadrupoles and isolation transformers	40
<i>ICMflex</i>	22	Coupling capacitors	41
<i>ICMflex GRC</i>	23	Preamplifiers	42
<i>AIACompact</i>	24	Current transformers	44
		Bushing accessories	45
<b>Loss factor measurement</b>		Filters	46
<i>TDACompact</i>	25	Miscellaneous	47
		<b>Special software</b>	49
<b>Fibre optic transmission systems</b>		<b>Services</b>	50
FOS1, FOS2, FOS3	26		
FOS4	28		
<b>Calibrators</b>			
CAL1, CAL2, CAL3 series	29		

# PRODUCT SELECTION GUIDE FOR PD MEASUREMENT PRODUCTS

		ICMsystem Gen. 5	ICMcompact	AIACompact
				
<b>GENERAL DESCRIPTION</b>		<b>Modular partial discharge measurement system</b> Sync. range: 20–510 Hz (autom.) / 0.02–510 Hz (man.)	<b>Stand alone partial discharge detector</b> Sync. range: 6–505 Hz / VLF (0.02/0.05/0.1 Hz)	<b>Acoustic and UHF PD analyser</b> Sync. range: 10–520 Hz
<b>MAIN APPLICATION</b>	Transformers	●	●	
	Rotating machines	●	●	
	GIS	●	●	●
	AIS	●	●	●
	Cables	●	●	
	Other components	●	●	
<b>USAGE</b>	Factory acceptance tests	●	●	
	On-site off-line test	●	●	●
	On-site on-line test	●	●	●
	On-line monitoring			
<b>PD MEASUREMENTS</b>	HF IEC	●	●	
	HF VHF	●	●	●
	UHF	●		●
	Acoustic	●		●
<b>SPECIAL FEATURES</b>	Time domain reflectometry	●	●	
	DC recording	●		
	Time of flight			●
	Spectrum analysis	●	●	
	RIV measurement	●	●	
<b>TAN DELTA</b>				
<b>EXT. SYNC. VOLTAGE MEASUREMENT</b>		●	●	
<b>NO. OF CHANNELS</b>	Multiplex		4 / 12	4 / 12
	Simultaneous	1 to 10		
<b>OPERATION</b>	without PC		●	●
	with PC	●	●	●
<b>INTERFACES</b>	USB	●	●	●
	Bluetooth		●	
	LAN	●	●	
	GPIB	●		
	Modem	●	●	●
<b>ENCLOSURE</b>	Desktop enclosure	●	●	●
	Explorer case		●	●
	Rack mountable		●	
	Hat rail mountable			
<b>PAGE NUMBER</b>		20 and 21	19	24



Partial Discharge Monitoring Systems			
ICMflex	ICMflex GRC	ICMmonitor	GISmonitor
			
<b>Partial discharge and Tan Delta measurement system</b> Sync. range: 20 Hz–510 Hz/ VLF (0.02/0.05/0.1 Hz)	<b>Partial discharge and IEC 60034-27-3 Tan Delta measurement device</b> Sync. range: 20 Hz–510 Hz/ VLF (0.02/0.05/0.1 Hz)	<b>Partial discharge monitoring system</b> Sync. range: 8–320 Hz	<b>Partial discharge monitoring system for GIS</b> Sync. range: 20–350 Hz
		●	
●	●	●	
		●	●
●		●	
		●	
●	●		
●	●	●	●
		●	●
		●	●
●	●	●	
		●	
		●	●
		●	●
●	●	●	
●			●
		●	
1	1	4 / 8	8 / 16 / 24 / 32 / 40
●	●	●	●
●	●	●	●
		●	●
		●	
		●	●
		●	●
		●	●
		●	●
22	23	14 to 16	17 and 18



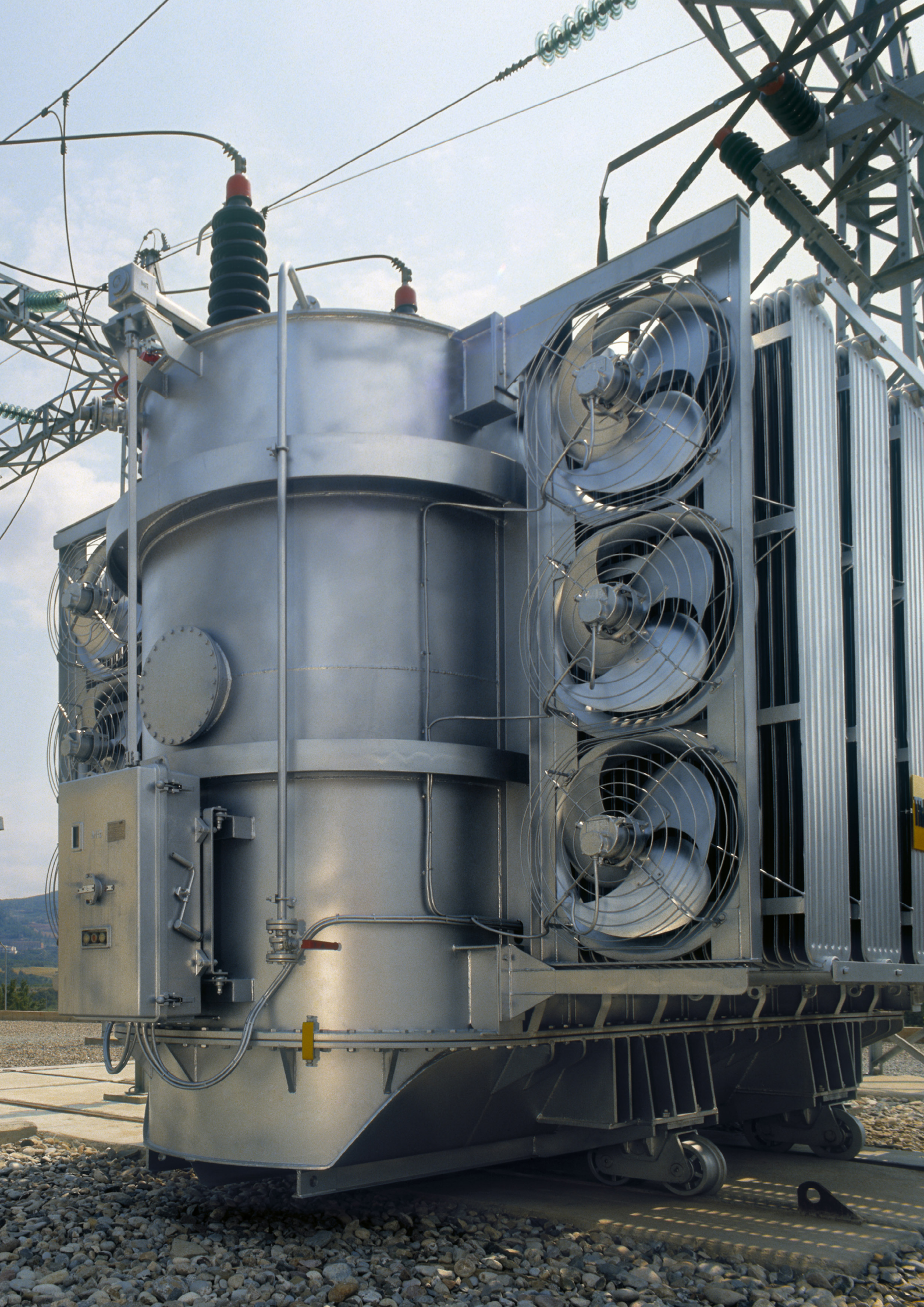



# Product application

## Transformers

Partial discharge measurements on power and distribution transformers are a proven tool to identify and locate insulation defects within windings, instrument transformers, bushings, tap changers, or other accessories. Besides providing the required equipment for factory acceptance testing (FAT), Power Diagnostix offers a wide range of instruments for on-site investigations and for continuous on-line monitoring. Such off-line or on-line measurements in the field generally serve as an in-depth verification of an initial trigger by a PD monitoring system or suspicious dissolved gas analysis results and can provide essential information about ongoing deterioration of components of the active part and bushings, for instance. Currently, off-line partial discharge testing in the field after commissioning of new units is an emerging trend and already proved to be very effective to detect assembling or processing deficiencies. In these days the permanent PD surveillance of transformers in the grid is a proven technology to prevent unforeseen outages or irreparable damage. Accurate monitoring of phase resolved PD patterns and alarm thresholds are the required indicators to monitor in order to avoid a breakdown or system failure. With the *ICMmonitor*, Power Diagnostix provide such compact, stand-alone and remotely accessible continuous monitoring system for power transformers offering accurate alarm functionality with consequent pre-warning messages to prevent worst case scenarios.



*ICMsystem with nine channels*

The multi-channel *ICMsystem* Gen. 5 greatly simplifies the PD acceptance tests on large power transformers. With its true parallel PD acquisition on up to ten channels, the overall testing period is substantially shortened by features such as the automatic calibration cross coupling matrix. A typical package for advanced PD analysis consists of a multi-channel *ICMsystem* offering both narrow and wide band PD pattern acquisition according to IEC 60270. The instrument comes with an embedded spectrum analyser for PD analysis in frequency domain. Moreover, it is an excellent tool to use in case of noisy test environments. New in this fifth generation is the embedded digital storage oscilloscope (DSO) for time domain analysis of electrical and acoustic signals. The *ICMsystem* software further offers direct transmission of acoustic time domain measurements to the *ICMacoustic* PD location software, providing an accurate graphical and mathematical triangulation functionality to locate PD defects in the main tank with high precision.

The *ICMcompact* with SPEC option is a good compromise for routine factory PD testing of distribution class transformers and instrument transformers. Its user friendly interface enables non-

PD-experts to efficiently handle factory acceptance testing. The embedded 40 kHz to 10 MHz spectrum analyzer and effective noise gating features are excellent tools to cope with noisy factory environments. In addition to the noise suppression functions of the instruments, Power Diagnostix offers a wide range of high voltage filters for induced or applied voltage testing.



### PD MONITORING

Partial discharge monitoring has become increasingly important in the past few years. Besides other parameters, such as dissolved gas analysis, temperatures, vibrations, or load conditions, etc., the PD trending information completes a full set of monitoring data of a power transformer in the field. A wide range of standard bushing adapters (BA) is available to connect the measurement system to the capacitive tap of condenser bushings. Even special designs are available on request. Additionally, the standard setup using the bushing test tap could be extended with UHF drain valve sensors or embedded antennas in flanges. A good alternative for continuous monitoring are periodical on-line PD measurements using an *ICMsystem* or *ICMmonitor* Portable. In such case, signal decoupling can be done by either temporary installed measuring impedances or a permanent setup with bushing adapters (BA) and bushing coupling units (BCU).

### TYPICAL PACKAGES

#### Set for power transformer acceptance testing:

- 1 x *ICMsystem* Gen. 5
- 1 x Built-in TCP/IP interface
- 1 x GPIB interface
- 1 x Software *ICMsystem* Gen. 5
- 1 x Impulse calibrator CAL1D or CAL1B
- 9 x Preamplifier RPA1 or RPA1L
- 8 x Quadropole CIL4M/V0 $\mu$ 5/2 $\mu$ 0
- 3 x Quadropole CIL5M/V4 $\mu$ 0
- 3x T100/100 high voltage filter

#### Set for distribution transformer acceptance testing:

- 1 x *ICMsystem* Gen. 5 or *ICMcompact* (incl. MUX4)
- 1 x GPIB interface (with *ICMsystem*)
- 1 x Software *ICMsystem* Gen. 5/*ICMcompact*
- 1 x Impulse calibrator CAL1D
- 4 x Preamplifier RPA1 or RPA1L
- 3 x Coupling capacitor CC100B/V
- 3 x T30/xx or T50/xx high voltage filter







# Product application

## Rotating machines

The epoxy-mica stator winding insulation of rotating machines is a 'forgiving' insulation system. Due its dielectric stability, partial discharge activity acts as an indicator for a variety of defect mechanisms. Besides the normal thermal ageing, further problems, such as end winding contamination, bar or overhang vibrations, deterioration of grading layers, loose wedges, or large internal delaminations are common practice and can be classified by analysis of the phase resolved pattern properties. Partial discharge testing and monitoring on generators and large motors offers a detailed stator winding condition assessment. This helps avoiding unplanned outages as well as scheduling efficient maintenance turn intervals.

### PD MEASUREMENTS

Power Diagnostix offers various instruments for continuous monitoring, schedule-based routine testing and in-depth analysis of rotating machinery. The instruments and their control software were continuously improved based on the feedback and requirements of the end users. Permanently installed partial discharge couplers greatly simplify periodical on-line testing using the ICMsystem without any interruption or downtime. Continuous on-line PD monitoring with a permanently installed ICMmonitor helps optimizing maintenance intervals and reducing costs, while improving the level of equipment reliability.



ICMsystem Gen. 5

### PARTIAL DISCHARGE MONITORING

Based on the stand-alone ICMmonitor unit connected to an individual machine, larger networks supervising a multitude of generators in combined-cycle thermal power plants or pump-storage hydro power plants have been realised. Such networks include full control of the local instrument via global Intranet access as well as visualisation of the monitoring data in monitoring centres. The ICMmonitor software offers automated scanning, pattern acquisition, and analysis of the trending data, while the ICMserver software operates in the background to supervise the communication between the individual instruments and data servers.



ICMmonitor Portable

### LARGE MOTORS

High voltage motors are the main assets to keep compressors, cooling pumps, extruders and large fans running in refineries, oil and gas plants, chemical and petrochemical industry. Here, unplanned outages can cause immense losses. Not only for the HV motor in particular, but to clean pipelines with remaining product or compressor and extruders that have stalled by motor failure. Further, such motors act as auxiliary drives in thermal and nuclear power plants to run the (emergency) cooling system, for example. Here, failure of the stator winding can cause critical subsequent damage. Given the typical 5-yearly outages for such setups, permanent installation of capacitive couplers offers periodical on-line PD measurements, and, hence, the possibility for an accurate and short follow-up. For the most critical trains, continuous monitoring can be installed from the early beginning.

### TYPICAL PACKAGES

#### Advanced PD measurement system (off-line and on-line):

- 1 x ICMsystem Gen. 5 (incl. option spectrum analysis)
- 1 x ICMsystem software
- 1 x GPIB interface
- 2 x Preamplifier RPA1H
- 1 x Preamplifier RPA2 (for on-line testing)
- 1 x High frequency current transformer CT1 or CT100 (opt.)
- 1 x Impulse calibrator CAL1B
- 1 x Set of cables
- 1 x Off-line coupling capacitor, e.g., CC25B/V

#### Standard PD test system (off-line):

- 1 x ICMcompact (opt. MUX4 and gating)
- 1 x ICMcompact software
- 1 x Preamplifier RPA1 or RPA1e
- 1 x Impulse calibrator CAL1B
- 1 x Set of cables
- 1 x Off-line coupling capacitor, e.g., CC25B/V

#### Combined PD and TD measurement equipment (off-line):

- 1 x ICMflex incl. software
- 1 x Impulse calibrator CAL1B
- 1 x Set of cables







# Product application Switchgear (GIS/GIL)

Besides factory partial discharge testing for quality assurance, field-testing becomes increasingly important for gas-insulated equipment. For the field applications UHF and acoustic detection methods complement the low frequency detection according to the IEC 60270.

Power Diagnostix's range of instruments cover the entire needs of partial discharge testing on gas-insulated substation equipment from acceptance testing and commissioning to maintenance and monitoring.

## ICMcompact

The *ICMcompact* combines perfectly with small tank-type variable frequency test sets for the commissioning testing of gas-insulated substation equipment. Besides the flexible analogue gating function, the *ICMcompact* comes with a TTL gating input to effectively suppress the switching impulses of the resonant test set.



*ICMcompact*

## AIACompact

The *AIACompact* combines the complimenting acoustical and electrical partial discharge detection for gas-insulated equipment in a lightweight and battery operated instrument. The measurement inputs provide the supply voltage for different pre-amplifiers and acoustic sensors. It automatically selects the appropriate operation mode for each test setup. The *AIACompact* comes with a built-in display and can be operated via its integrated push-buttons.



*AIACompact*

Measurements can be stored and transmitted to a laptop or PC for further analysis.

## ICMsystem

For in-depth field analysis of partial discharge activity the *ICMsystem* can be combined with a spectrum analyser. Power Diagnostix developed the special software *ICMspectrum* to utilise and control spectrum analysers of different vendors for partial discharge analysis (HP 859xE, Agilent E4000, R&S FSL).



*ICMsystem Gen. 5*

## PARTIAL DISCHARGE MONITORING

The same UHF sensors (external or internal) as used for commissioning can be used for continuous on-line monitoring of the partial discharge activity. Here, acquisition units perform a real-time parallel measurement on a number of sensors, each directly connected to a small frequency converter unit (FCU2). This preprocessing unit acts as a detector and converts the ultra-wide bandwidth signal into a low-frequency envelope signal, which is then conveniently transmitted via regular RG58 cable. The RG58 cable also provides the DC supply for the pre-acquisition units. Embedded UMTS units or TCP/IP interfaces offer remote access to a multitude of monitoring units via the Internet, an Intranet, or the mobile telephone network.

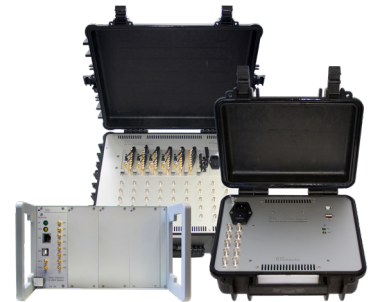

*GISmonitor Portable*

## TYPICAL PACKAGES

### Standard PD test system for shop floor testing:

- 1 x *ICMcompact* (opt. MUX4, gating)
- 1 x *ICMcompact* software
- 1 x Preamplifier RPA1
- 1 x Quadrupole CIL4M/V2 $\mu$ 0 for SF6 bushings, or
- 1 x Coupling capacitor, such as CC50B/V, CC100B/V for AIS
- 1 x Impulse calibrator CAL1A
- 1 x Set of cables
- 1 x Software for remote control, recording, and reporting

### Standard PD test system for on-line and off-line testing:

- 1 x *AIACompact* (opt. MUX4 or MUX12, gating)
- 1 x *AIACompact* software
- 2 x Frequency converter unit FCU2
- 2 x Input protection unit IPU2
- 1 x Acoustic sensor AS75I incl. sensor fixture
- 1 x Disturbance antenna DA2
- 1 x Impulse calibrator CAL2B
- 1 x Set of cables







Polyethylene is a 'non-forgiving' insulation system. Thus, close attention must be paid to partial discharge activity during factory testing, commissioning, and service. On-site measurement techniques have to cover the needs of an aging polymeric cable distribution net as well as an increasing application of polyethylene extra high voltage cables.

Combining the ICM*flex* or the lightweight ICM*compact* for partial discharge location with portable VLF high voltage sources or variable frequency resonant test sets offers cost-effective survey testing of a distribution grid.

## EXTRA HIGH VOLTAGE (EHV) CABLES

Cables are generally factory-tested. The accessories of high voltage (HV) and extra high voltage (EHV) cables are usually also pre-tested. However, mechanical forces during the laying, hidden imperfections, and flaws caused by improper handling, for instance, require partial discharge commissioning tests.

Ideally, the cable accessories of such transmission-class cables are equipped with embedded sensors. Power Diagnostix introduced this cost-effective principle in 1994 and numerous cable manufacturers have implemented it since then. The ICM*system*, especially if enhanced with the FO*system* for optical isolation, offers powerful tools for the analysis of the cable insulation system.

Additionally, different preamplifiers and embedded or external spectrum analysers complete the instrumentation.

## MEDIUM VOLTAGE CABLES

As with HV and EHV cables, the ICM*compact* is used for shopfloor production testing on medium voltage cables and ICM*flex* applications include HV/MV cable acceptance testing, MV/HV cable on-site testing and cable joints and accessories (laboratory/on-site). During the past decade numerous cable manufacturers have changed to this instrument during the modernisation of their test room. A large population of service-aged medium voltage or distribution-class cables has reached their projected service life, as polymeric cables were increasingly introduced since the 1970s. The ICM*compact* is available in a ready-to-use package for field testing and partial discharge location with any external high voltage source. Especially the combination with very low frequency (VLF) sources and the combination with variable frequency resonant test sets provide lightweight and cost-effective solutions to keep the distribution grid reliable. The package includes a combination of T-filter and coupling unit to reduce the high frequent disturbance signals from the HV source.

## SPECIAL SENSORS

Coupling capacitors, as used for factory testing and for off-line testing, are not applicable for on-line testing. Power Diagnostix offers several types of external sensors for PD measurements. The differential foil sensor (DFS) makes use of the stray capacitance of cross-bonding joints and offers comparable low-noise measurements at higher frequencies.

The CT100 is a clamp-on HF current transformer that can be used to pick up partial discharge signals on ground leads and on cross-bonding connections.

Further sensors including Rogowski coils can be tailor-made for any application. Power Diagnostix also assists with the design and implementation of embedded sensors.

## PD MONITORING

Generally, partial discharge monitoring can take care of any high voltage insulation system to detect incipient breakdown and on-going degradation.

The defect mechanisms for cable accessories and for the cable itself differ due to different material properties, for example. When monitoring EHV cables systems, a comparable long pre-warning time applies to EPR and EPDM accessories, while the cable insulation of a 400 kV XLPE cable, for instance, has a much shorter pre-warning time.

Further, an installed monitoring system can also be used for the commissioning tests of the cable system.

## TYPICAL PACKAGES

### Mobile PD fault location system:

- 1 x Portable ICM*compact* with built-in DSO board
- 1 x Software ICM*compact* with PD fault location
- 1 x Coupling capacitor CC25D/V or CC100D/V
- 1 x Optional high voltage T-filter
- 1 x Impulse calibrator CAL1B
- 1 x Preamplifier RPA1L
- 1 x Preamplifier RPA1
- 1 x Set of cables

### Combined PD and TD measurement equipment:

- 1 x ICM*flex* for 30, 50, 100, or 150 kV<sub>rms</sub>
- 1 x ICM*flex* software
- 1 x Reference and coupling capacitor RC30, RC50, RC100, or RC150
- 1 x HV filter like T30/05, T50/05, T100/05, or T150/05
- 1 x Battery pack plus charger
- 1 x Transportation case
- 1 x Impulse calibrator CAL1B
- 1 x Set of cables
- 1 x Laptop computer

# ICMmonitor

## Partial discharge monitoring system

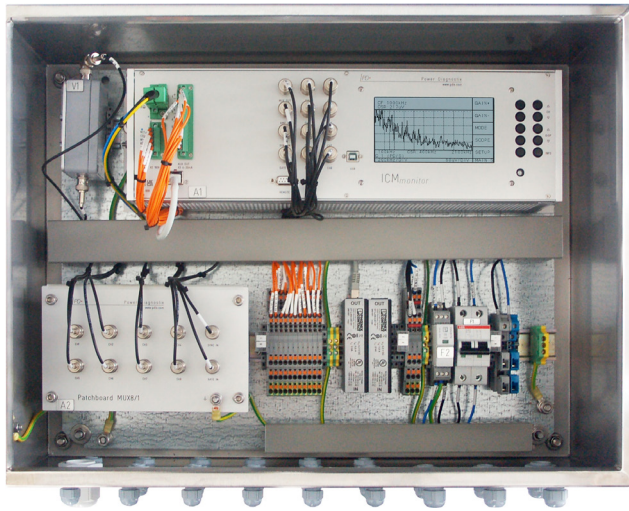

The ICMmonitor is a partial discharge analyser comprising a spectrum analyser, an acoustic detector, and a conventional partial discharge (PD) monitor in one instrument. This combination enables PD measurements even with a large background noise, e.g., on power transformers within substations or power plants. This monitoring system for fixed indoor or outdoor installation is used principally for permanent, continuous on-line monitoring of rotating machines, cable systems, and power transformers.

The multifunctional ICMmonitor, with its embedded display, convenient trending, and settable alarms, is an ideal solution for the permanent survey of electric devices in industrial and utility applications.

### EMBEDDED DISPLAY

The ICMmonitor has an easy-to-use push-button interface to navigate on-screen menus displayed on an embedded LCD panel. The LCD modes include a monochrome phase-resolved PD pattern display for classification of defects, a scope-like display showing charge pulses as a vertical line at the phase angle where they occur, a time trending display, and a monitoring display showing bar graphs of two key partial discharge quantities (Qp and NQS). Qp is the apparent charge value of the PD activity, and NQS is the absolute discharge current obtained by integrating the discharge values (summing up the total charge moved and dividing by the time interval,  $Q/t = [As]/[s]$ ).

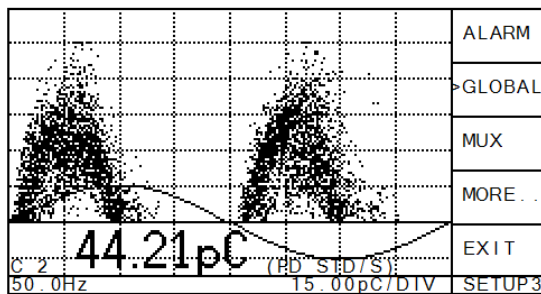

Monochrome PD pattern display

### TELEMONITORING

With its built-in TCP/IP interface or an analogue modem, the instrument can be controlled and observed remotely over a telephone or Internet connection anywhere in the world. An optional mobile communication interface (MCI2) enables remote access via UMTS. Optionally, if a monitored system exceeds an alarm level set by the user, the ICMmonitor can place a call to a user-selected number.

### SPECTRUM ANALYSIS

Observing the frequency spectrum of a harshly disturbed PD signal allows the selection of frequency bands with fewer disturbances. Using this centre frequency for a PD acquisition, gives a largely improved signal-to-noise ratio resulting in a clear pattern acquisition. The combination of spectrum analyser and PD detector within one instrument greatly expands the measurement possibilities when analysing the insulation systems in a noisy environment.

The ICMmonitor with spectrum analysis comes with a four- or eight-channel multiplexer to directly select the input signal. The instrument provides five different display modes as well as a variety of connectivity options, including TCP/IP and USB.

### ICMmonitor SOFTWARE

The ICMmonitor can be connected to a computer via serial interface, modem, or TCP/IP. Special software allows the remote control of the instrument and the download of the stored data, such as instrument setups, NQS and Qp values, alarm events, projection data, and coloured PD pattern.

An auto-scan function takes the trending information as well as the phase-resolved pattern of one or multiple units.

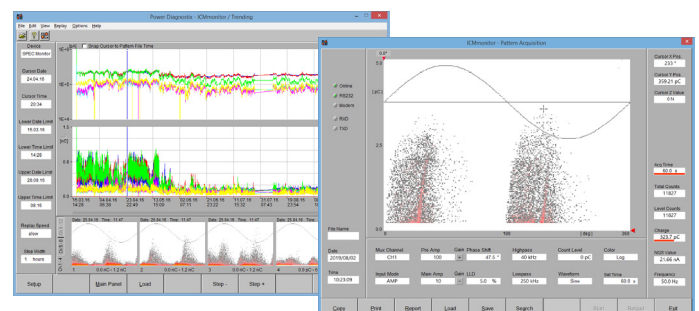



# ICMmonitor Partial discharge monitoring system

## EXPANDABILITY

The ICMmonitor can be equipped with several optional features to adapt the instrument for special acquisition tasks or to easily integrate it into third-party assets.

### MUX8/MUX12

- 8 or 12 input channels for PD and synchronisation signals.

### IEC61850 HW interface

- OS independent hardware based communication gateway
- Provision of ICDs for third-party data integration
- Full description of all data sets and IEC 61850 relevant documents
- Provided data sets: E.g., current readings of NQS, Qp, alarm status



### AUXOUT4/AUXOUT8

- Up to eight additional output signals of 4–20 mA or 0–10 V DC can be provided for external monitoring purposes

### AUXIN4/AUXIN6/AUXIN8

- Up to eight additional sensor signals of 4 to 20 mA or 0 to 10 V DC can be measured and recorded.

### PDMAR500

- Compact design
- Built-in ICMmonitor, CTB, network interface, IOs, main switch,...
- User-friendly interface
- Corrosion proved design
- High quality PTFE coaxial cables suited for extreme weather conditions on-site
- Heating installation or cooling system possible
- Stainless steel enclosure with protection class IP52



### ICMoutlander

- Dust- and watertight Explorer case with Ingress protection class IP65

### ICMexpert

- Advanced data management
- Database-supported handling of all measurement files
- Supplementary information
- PD pattern comparison
- PD pattern classification
- Storage of photos, comments, and all instrument settings with each data set

### Web-based data access and visualisation MWS

The mobile web server MWS offers a web interface for convenient set up of monitoring parameters and handling of collected data from anywhere in your network. The instrument's event log and corresponding PD data can be instantly visualised and analysed remotely.



- OS independent
- Direct access via local IP address
- Full description of API
- Access to specified data sets provided by the instrument
- Data can be stored to external database with 64 GB capacity

# ICMmonitor Portable

## Portable PD monitoring device



The ICMmonitor Portable is part of the Power Diagnostix ICM series of digital partial discharge detectors. It is a compact, stand-alone instrument for evaluating the condition of medium and high voltage insulation. A built-in four- or eight-channel multiplexer offers scanning of three-phase systems or multiple sensors.

The ICMmonitor Portable is an autonomous instrument, which can be used as stand-alone monitoring device. However, it is equipped with a serial computer interface for download of trending data and remote access, e.g., by LAN network (TCP/IP). The system can be adapted to utilise all commonly used types of couplers and sensors.

### VERSATILITY

A broad range of standard accessories is available to adapt the test set-up to specific customer needs, e.g., bushing adapters and bushing coupling units for permanent installation connect the ICMmonitor Portable to the test tap of transformer condenser bushings, and different types of coupling capacitors in combination with coupling terminations boxes serve for monitoring of large motors.



### ALARMS AND TRENDING

Users can set alarm levels of the apparent charge value of the PD activity ( $Q_p$ ) or the absolute discharge current (NQS) that will trigger when those values are exceeded. A triggered alarm will appear on the LCD and activate an output relay on the ICMmonitor Portable, that can be used to drive a local alarm system. The instrument also collects and displays PD data over a specified time interval for easy trending and observations of changes in the  $Q_p$  and NQS levels in the monitored system. Optionally, up to eight DC signals, such as temperature or load, can be added to this trending.

### NOISE REJECTION

The ICMmonitor Portable features various noise handling techniques. The noise gating module can be connected to an antenna or a current transformer to sense and remove noise without losing significant PD data. Another method available is simple windowing that suppresses phase-stable pulses occurring in the defined windows. Additionally, an appropriate choice of external preamplifiers can limit PD acquisition to a frequency band with less background noise.

### DISPLAY MODES

#### SPEC

The spectrum display shows the frequency spectrum of the input signal up to 10 MHz. Three traces for the current input channel allow storing, comparing and processing of this spectrum. The bandwidth of the demodulated signal can be set to 9 kHz or 270 kHz, respectively.

#### SCOPE

The SCOPE mode displays the PD pattern versus phase as known from the ICM series. Hereby, the selected centre frequency and bandwidth of the SPEC mode is used, in order to disregard frequency ranges occupied with disturbances.

#### MON

The monitoring display allows setting alarm levels of NQS or  $Q_p$  that will trigger when those values are exceeded.

#### PROJ

The projection display mode PROJ shows the amplitude distribution graph of the measured PD pulses. This distribution graph reveals the contribution of each charge amplitude to the overall discharge current (NQS).

#### TIME

Additionally, the ICMmonitor Portable collects and displays PD data over a specified time interval for easy trending and observations of changes in the  $Q_p$  and NQS levels of the monitored system.



# Partial discharge monitoring on GIS

The GISmonitor builds on more than 20 years of experience in on-line PD monitoring on rotating machines, transformers, cables, and especially GIS systems. It combines proven technology of the ICMmonitor with new processor technology and embedded hardware capabilities. The hardware core of the system has been optimised for parallel, real time PD acquisition on multiple channels. Any UHF signal can be detected and digitised within micro seconds. A separation of PD events from external disturbances or internal switching pulses is calculated in real time and, therefore, an effective PD and alarm detection is given. Each eight-channel acquisition plug-in board operates fully stand alone, but can be combined with a virtually unlimited number of units, to monitor all PD sensors in one or even multiple GIS in parallel. A partial discharge monitoring acquisition rack (PDMAR) carries up to 15 plug-in boards – each with eight channels – providing up to 120 channels. An industrial type PC installed in a partial discharge monitoring control rack (PDMCR) reads all data of the instruments via the high speed fibre optic LAN ring, providing communication redundancy. Storage redundancy is provided due to a RAID controller and data mirroring on multiple drives. Each cabinet comes with an uninterruptible power supply, a network switch and temperature controlled cooling and heating. Cabinets for indoor applications feature a protection class of IP54, while cabinets for outdoor applications reach a protection class of IP65.



## FEATURES

- Parallel UHF PD measurement on all channels
- Parallel reading of PD peak values, PD scope amplitudes, and PD patterns
- Separate gating input channel
- Automatic alarm detection algorithm
- System redundancy
- Suitable for embedded and external retrofit UHF sensors
- Scalable system configuration
- Automatic noise suppression mode
- Network-based communication

The GISmonitor is designed to suit all currently available UHF sensors for GIS PD monitoring. This includes embedded and external retrofit UHF sensors. A special input protection unit (IPU2) blocks strong transients (VFT). The pre-processing unit FCU2 de-modulates UHF signals into a lower frequency band. These lower frequency signals can be transmitted by coaxial cables and allow a compact and centralised design of the system. The user interface software panel of the GISmonitor monitoring system is installed on the local industrial PC and can be installed additionally on any remote computer for data evaluation and diagnosis. The graphical user interface is customised for each system and provides a user friendly overview of the current system status.

## SOFTWARE FEATURES

- User friendly software panel including a customised GIS overview diagram indicating all sensors and its current activities
- Additional analysis and trending panel displaying  $U_{pp}$ ,  $U_{pavg}$ , scope, and pattern information of each channel at every time stamp
- Alarm event list indicating peak levels, PD patterns and trend information
- PD trending and PD pattern information of the full history
- Typical PD failure database
- Automatic data storage
- Interface to third party control systems, such as SCADA, IEC 61850, and others.

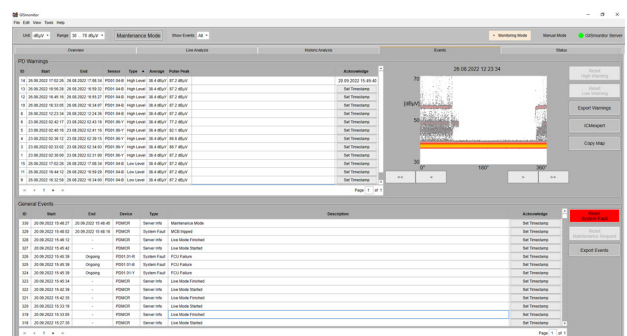

GISmonitor software



# GISmonitor Portable

## Partial discharge monitoring on GIS



This GISmonitor Portable is a portable unit for temporary monitoring of partial discharge activity on gas-insulated switchgear (GIS) caused by hopping particles, floating potentials, cracks in insulators or spacers, or other degradation in the insulation system.

The instrument offers parallel real-time PD acquisition on up to 40 channels. To eliminate disturbance signals from the measurement, the instrument can be connected to a disturbance antenna that provides a gating signal.

### MEASURING PRINCIPLE

Partial discharge measurements can be easily applied on gas-insulated switchgear without the need of interrupting the operation. Such on-line measurements help to identify internal imperfections of the insulation system, which may lead to breakdown and system failure in the future.

Due to the dielectric properties of the SF6 gas, partial discharge activity in gas insulated switchgear covers a bandwidth of well beyond two GHz. The mechanical properties of the components of gas insulated switchgear further allow transmission of such signals over a distance of a couple of metres. Thus, the partial discharge monitoring of GIS equipment is done preferably in the UHF range.

### SENSORS

The GISmonitor Portable is designed to suit all currently available UHF sensors for GIS PD monitoring. This includes embedded and external retrofit UHF sensors. A special input protection unit (IPU2) blocks strong transients (VFT). The preprocessing unit FCU2 demodulates UHF signals into a lower frequency band for easy submission over longer distances.

### ENCLOSURE MODELS

The instrument is available with different housings: Portable, lightweight desktop enclosures of half 19 inch and 19 inch as well as shock resistant and watertight outdoor cases.

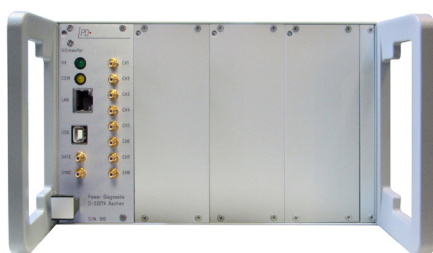

GISmonitor Portable as desktop version

### SOFTWARE

The instrument can be connected to a PC or laptop via a USB or an optional LAN interface for data evaluation and diagnosis with the GISmonitor Portable software. The service program software visualises the current readings of the partial discharge sensors of a GIS in parallel. Each sensor is linked with a specific input channel of the GISmonitor Portable.

#### Monitoring Mode

The acquisition of partial discharge pulses is done versus phase position. The external or internal synchronisation signal determines the phase position of every PD pulse. The Live Analysis panel in this mode shows the partial discharge activity of up to 15 channels in parallel. A trending graph depicts the average and pulse peak values of all selected sensors.

#### Manual Mode

For commissioning purposes, the GISmonitor software offers a special commissioning display, which shows relevant data in three different modes: A view for normal operation, a view for HV tests, and a view to perform the sensitivity verification.

Every version of the GISmonitor Portable can also be used with the software of the non-portable GISmonitor systems.

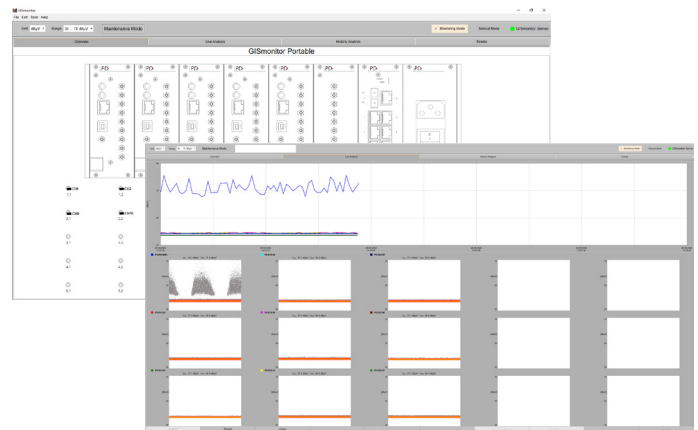

GISmonitor Portable software

# Digital partial discharge detector

The ICMcompact is part of the ICM series of digital partial discharge detectors. It is a compact, stand-alone instrument for evaluating the condition of medium and high voltage insulation. The ICMcompact is often used in quality assurance and quality control tests in manufacturing, but the instrument may be adapted to non-conventional testing tasks, such as field testing and diagnostics by use of various preamplifier and couplers.

The easy portability, simple operation, and flexibility of the ICMcompact make it a good choice for routine PD testing in a variety of utility and industrial applications.

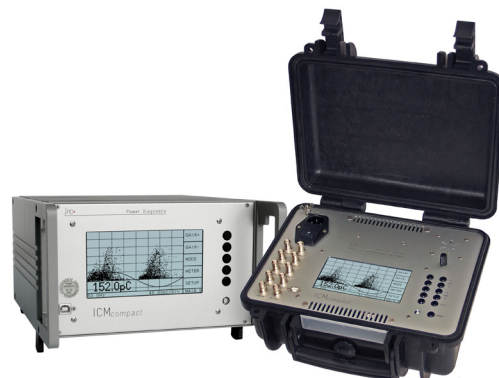

## STAND-ALONE INSTRUMENT

The Power Diagnostix ICMcompact provides a simple push-button interface and on-screen menus in an embedded LCD panel. The LC display modes include a simple PD charge meter with adjustable 'needle' sensitivity, monochrome phase-resolved PD patterns for classification of defects, and a scope-like display showing phase-summed charge pulses superimposed with a sine wave.

Although the ICMcompact is an autonomous unit, it can be connected to a computer installed with Power Diagnostix software to capture screenshots or to implement remote control of the unit.

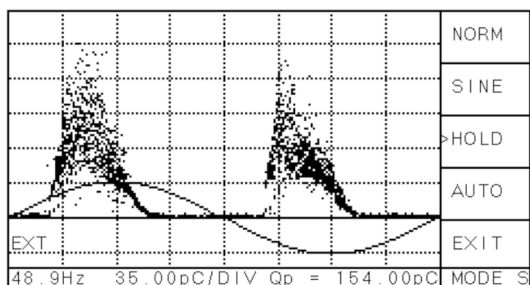

Phase-resolved PD pattern

## APPLICATIONS

Instantly displaying information in an intuitive interface, the ICMcompact is a good choice for applications, such as quality control tests in manufacture of electrical products and for quality assurance of industrial and utility equipment; from capacitors and bushings to gas-insulated switchgear, voltage transformers, and others. A wide range of accessories adapts the ICMcompact to specific testing applications and noise conditions.

The ICMcompact DSO option can be used to locate partial discharge defects in power cables. Using time domain reflectometry, in which the PD and its 'echoes' travel the length of the cable under test, the ICMcompact provides the proportional distance of the PD fault along the cable.

## PD SPECTRUM ANALYSIS OPTION

Observing the frequency spectrum of a harshly disturbed PD signal allows selecting frequency bands with fewer disturbances. Using this selected frequency for a PD acquisition gives a largely improved signal-to-noise ratio resulting in a clear pattern acquisition. The combination of spectrum analyser and PD detector within one instrument opens a broad field of new possibilities when analysing isolation defects even with large noise.

The SPEC mode shows the frequency spectrum of the input signal with a selectable span of up to 10 MHz. Three spectrum traces of the current input channel can be stored, compared, and analysed. A variable cursor serves to set the centre frequency for the PD pattern acquisition.

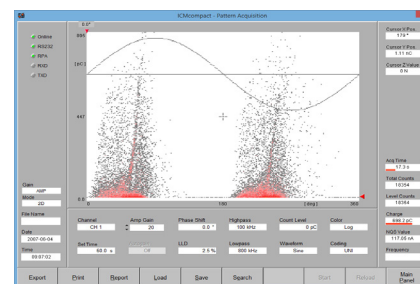

Software panel for pattern acquisition

## CABLE FAULT LOCATION

An additional DSO board allows sampling PD pulses and its reflections running over HV cables for cable fault location. The sample rate of this DSO function is 100 MSamples and gives a resolution of ten ns. An additional display mode with cursor settings and zoom functions helps to localise faults directly on-site. Advanced software gives more possibilities for evaluation and precise fault location using a PC or laptop.

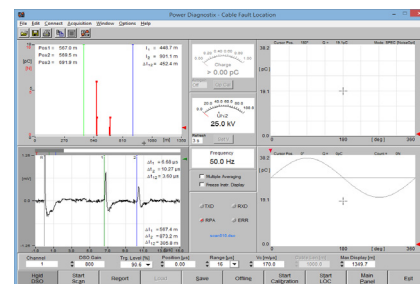

Software panel for cable fault location



# ICMsystem Generation 5

## Advanced partial discharge detector



The ICMsystem is part of the Power Diagnostix ICM series of digital partial discharge detectors. The ICMsystem is a powerful, versatile instrument for evaluating the condition of medium and high voltage insulation. The ICMsystem is usable over a range of frequencies of applied voltage, including power system frequency (50/60 Hz) and VLF (0.1 Hz).

The ICMsystem provides high-resolution digital PD patterns for classification of defects in high voltage insulation systems.

### VERSATILITY

The key to the versatility of the ICMsystem is its modular design. The ICMsystem can be matched up with a variety of special accessories that adapt it to virtually any high voltage testing environment.

Assorted coupling devices, including quadrupoles, coupling capacitors, and current transformers, are available to sense the PD signal in the object under test. Like the other instruments in the ICM series, the ICMsystem provides effective noise gating that blocks phase-stable noise as well as noise independent of the applied voltage cycle, allowing the ICMsystem to be used in noisy environments without losing significant PD data. Appropriate selection of a preamplifier can assist further in achieving a high signal-to-noise ratio.

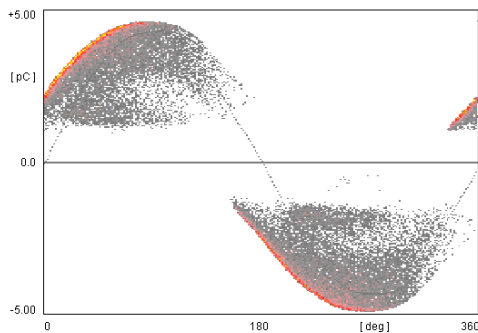

### PC SOFTWARE

The operating parameters of the ICMsystem are fully computer controlled, making it simple to use with standard Power Diagnostix software. The ICMsystem's PC software includes convenient options for in-depth analysis and printing of stored PD patterns.

For special applications and options for applications, such as DC testing or stepped high voltage testing, the ICMsystem allows recording PD activity versus time (sequentially) instead of versus phase angle.

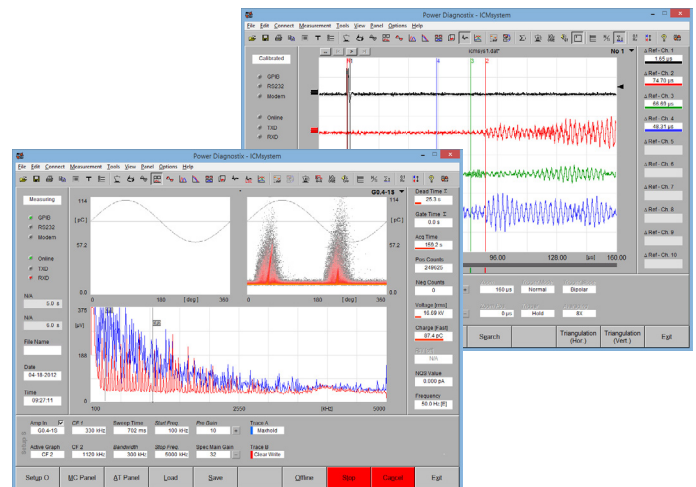

### OPTIONS

- Built-in spectrum analyser
- RIV measurement (according to CISPR and NEMA standard)
- Cable fault location
- Acoustic PD location
- Two to ten parallel input channels
- Transformer acceptance testing panel (for multi-channel devices)

Offering users complete access to detailed control parameters and the ability to download and analyse PD patterns on a PC makes the ICMsystem the ideal instrument for advanced analysis of phase-resolved partial discharge patterns, whether in research, utility, or industrial applications.

Using the multi-channel ICMsystem greatly simplifies partial discharge acceptance tests on large power transformers. With the true parallel acquisition of the partial discharge activity on up to ten channels, the overall testing period is substantially shortened.

# ICMsystem Generation 5 Advanced partial discharge detector

The multi-channel version of the ICMsystem is specifically designed to meet the requirements of partial discharge acceptance tests on large power transformers.

The instrument builds on the acquisition core of the standard ICMsystem. However, by introducing an individual amplifier plug-in board for each channel, true parallel acquisition of the discharge magnitude of up to ten channels is achieved. The instrument can be equipped with optional features like RIV or acoustic PD measurement.



ICMsystems with nine and ten channels

## INDEPENDENT CHANNELS

For each of the partial discharge measurement channels an independent quadrupole, preamplifier, and amplifier plug-in board is required.

Internally, the system controller processes the discharge readings acquired for each channel in a true bipolar peak amplitude acquisition. Optionally, the PD readings can be weighted according to IEC 60270-2000.

Besides the partial discharge channels, the instrument offers the same number of independent channels for the measurement and sampling of the AC voltage signal provided by the quadrupole.

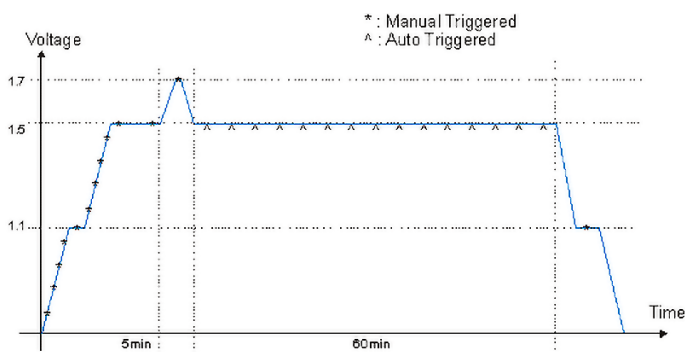

Typical test sequence for HV transformer

## PATTERN ACQUISITION

In addition to the parallel acquisition of the PD activity for the meter and strip chart displays, the pattern acquisition core known from the standard ICMsystem offers the defect identification capabilities of the phase-resolved partial discharge analysis. The influence of power frequency harmonics on the PD pattern, often found with power transformers, can be clearly identified, as the waveform of the AC voltage is available for each channel.

## SPECIALISED SOFTWARE

The control software for transformer acceptance testing offers manual and automatic modes for the acceptance test. Reporting is simplified with MS Word and plain text output formats. The reports are based on user-selectable templates.

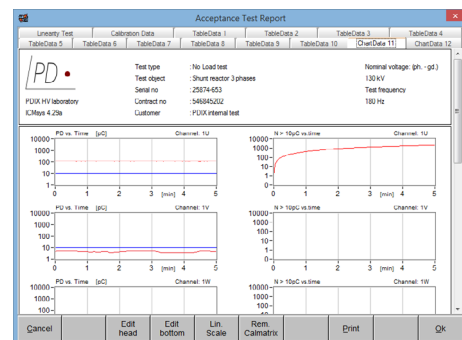

Report data

In acceptance test mode, the software shows up to ten meter displays, each indicating PD level, voltage, and frequency of the specific channel. With the centre display, the automatically or manually triggered values are presented in list mode or as a strip chart. Further, during calibration, the crosscoupling matrix between the channels is built-up, which offers essential information in case of PD location measurements on transformers. Additionally, the multichannel ICMsystem software provides the user with all the features known from the standard ICMsystem, such as multi-channel consecutive pattern acquisition, movie-like replay, or statistical evaluation, for instance.

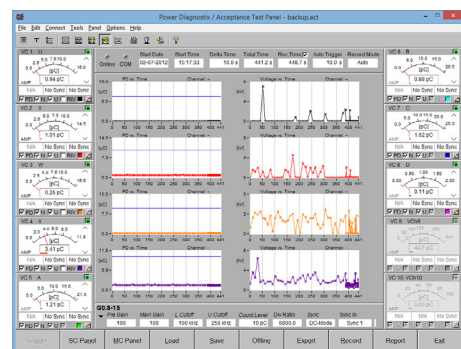



# ICMflex

## Partial discharge and tan delta measurement system

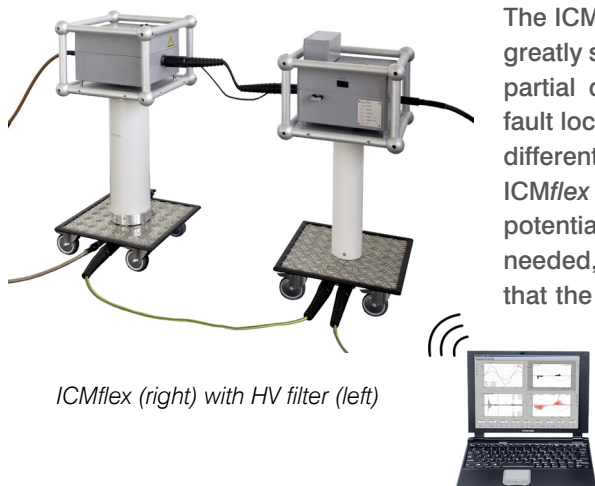

ICMflex (right) with HV filter (left)

The ICMflex high voltage instrument family offers inherent operator safety and greatly simplifies distribution-class cable testing and other field tasks involving partial discharge detection, loss factor (tan delta) measurements, and PD fault location. It has been designed to simplify the application and to combine different measurement tasks with one instrument. With the unique concept of the ICMflex instruments, the entire acquisition hardware is placed on high voltage potential right at the position where the signals are. Thus, no signal cables are needed, as the instrument is fully self-contained and battery operated. In case that the instruments are used for measurements in an environment with high frequency (HF) disturbance, they can be equipped with a gating input for effective noise reduction. Every ICMflex instrument is fully remote controlled via Bluetooth or fiber optic communication. Using wireless Bluetooth or fibre optic technology the ICMflex tan delta and partial discharge analyser family increases operator's safety and greatly simplifies off-line testing and analysis of distribution-class cables and rotating machine stator windings.

### UNIQUE CONCEPT

The ICMflex instrument family is available with different options and for different voltage levels. Additionally, the self-contained ICMflex acquisition unit can be placed on top of any third-party coupling or reference capacitor. The option TD offers tan delta and power factor (PF) measurements. The option PD provides partial discharge measurements according to the IEC 60270, whereas the option LOC includes partial discharge location for power cables. Finally, the optional high voltage T-filter for sensitive partial discharge measurements can reduce disturbance signals from a high voltage supply. The detachable Ni-MH battery provides more than eight hours of continuous operation, while a second battery can be charged. Any high voltage AC source can be used including resonant test sets and VLF high voltage sources.

Testing distribution-class cables in a field environment becomes an easy and inherently safe task. The ICMflex unit is simply placed between high voltage source and the cable to be tested – no further leads required. Thus, with one unit requiring only high voltage and ground connection all essential measurements on laid power cable are performed in one step: Tan delta, partial discharge, and partial discharge location.

Off-line testing of generator and motor stator coils is simplified in the same way. Using any high voltage source, the critical AC measurements on the stator coil are done simultaneously: Tan delta, PF, and partial discharge.

### OPTION TD

The tan delta analyser uses an unbalanced bridge formed by internal shunt capacitors, the reference capacitor, and the device under test. Here, the ICMflex software shows tan delta, PF, capacitance, voltage, and frequency.

### OPTION PD

With the option PD the ICMflex software offers a meter display according to IEC 60270 and an oscilloscopic display of the partial discharge activity as well as a coloured  $\phi$ -q-n pattern based on the data received via Bluetooth or fibre optic connection. Placing the quadrupole and acquisition unit on high voltage potential greatly improves the sensitivity and avoids any noise pickup on signal cables.

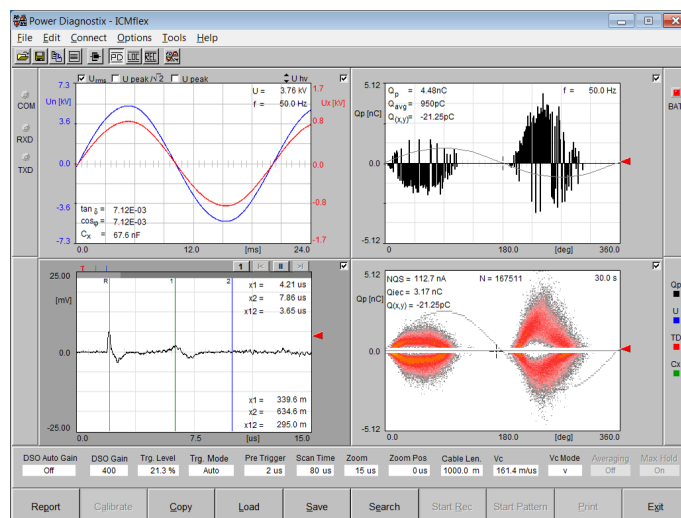

ICMflex software in PD mode

### OPTION LOC

The partial discharge location option uses high speed (100 Msample) sampling of the PD pulses traveling the cable. Along with the analogue bandwidth of 20 MHz this enables precise location and mapping of the discharge activity along the cable.

## IEC 60034-27-3 tan delta measurement device

In order to meet with the requirements of the existing IEEE 286-2000 and the new upcoming IEC 60034-27-3 standard for dielectric dissipation factor testing (also known as tan delta testing) on rotating machine stator windings and individual bars, Power Diagnostix made a re-design of the existing ICMflex, so called ICMflex GRC (Guard Ring Control).

Both standards mentioned above apply to rotating machinery with a rated voltage of 6 kV and higher and describe the test procedures and evaluation criteria for tan delta testing of individual stator bars and complete assembled stator windings. The testing as described applies to the common insulation system techniques in use, such as the resin rich and global vacuum pressure impregnated systems. However, the standards are not applicable for non-impregnated stator bars, also called green coils.



The main purpose of tan delta and tan delta tip-up testing is determining the overall condition of the stator winding or bar's slot section also called ground wall insulation. The test results mainly show the performance in terms ionisation losses versus the applied voltage of the ground wall insulation under the slot's conductive outer layer, acting as the ground electrode to the stator core.

Usually, the stator bars with a rated voltage of 6 kV and higher are provided of a field grading junction, consisting of a semi-conductive material, e.g., silicon carbide, at the slot-exit area. In order to grade the surface potential were the stator bar leaves the grounded core. Depending on the rated voltage, this high resistance material with non-linear resistive voltage characteristic needs to be overlapped for a certain length with the slot's linear resistive layer applied to the ground wall. Based on such design, the tan delta measurement, which is intended for the ground wall insulation only, may be affected by the resistive losses of the field grading junction. For complete assembled stator windings the contribution of the losses generated by the semi-conductive material in the overall tan delta level cannot be neglected, and, hence, the regular ICMflex can still be used. However, as the evaluation criteria are specified for the slot section of individual bars only, guarding techniques have to be applied in order to minimise the influence of the field grading junction's losses on the overall tan delta value.

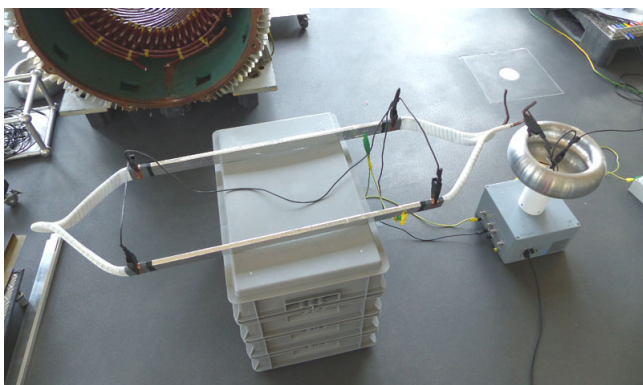

*Stator bar testing with ICMflex GRC*

Several techniques have been studied during the past, such as the foil wrap methods and the slot-end gap method. Nowadays, with automatised bar manufacturing processes, it is practically not feasible to make an interruption at the slot exit and to provide the semi-conductive material after the tan delta test, since this will cause tremendous delays and, in worst case, essential failures affecting the integrity of the insulation system. Besides this, both standards recommend performing the measurement on the end product, i.e., the individual bar provided with the field grading junction, and, hence, using both techniques as mentioned above are not an option. The only technique left is the driven guard method.

### IEC 60034-27-3 READY

The new GRC option provides such driven guard inputs on the ICMflex's digital tan delta bridge. Beside this new feature, the instrument still keeps its versatility by enabling the simultaneously updated partial discharge and tan delta measurement results with the highest precision. This flexible unique concept strongly reduces the (re)winding and testing times in rotating machine manufacturing companies and service groups and can even be used in quality assurance labs for non-destructive evaluation of the ground wall performance of individual stator bars.

The ICMflex GRC is optimised for the capacitance range of stator bars and for smaller asynchronous induction motors up to Roebel bars for larger synchronous turbo generators.

Furthermore, the embedded voltage divider for up to 30 kV RMS comes with a DAkkS (former DKD) calibration certificate. The instrument is battery operated (up to ten hours) and equipped with a fibre optic link for communication with the computer via USB. The advanced software provides manual and automatic record modes, even a step-by-step guidance structure with customised report after completing the test sequence. The data tables, phase resolved PD patterns, different charts, and graphs can be exported into common text and spreadsheet processing packages, such as MS Excel.



# AICompact

## Partial discharge measurement device

The AICompact is a portable unit for in-service acoustic and electric (UHF) partial discharge measurements on gas-insulated switchgear (GIS), transformers, and cable accessories. The instrument is fitted with a battery pack for independent operation up to three hours. It adapts to a variety of piezo-electric acoustic sensors and is supplied with a versatile sensor fixture. Additionally, the AICompact allows partial discharge measurements on external UHF sensors.

Offering easy-to-use acoustic partial discharge analysis of gas-insulated switchgear (GIS) and other high voltage equipment plus the optional analysis on embedded or external UHF sensors makes the AICompact the ideal solution for convenient in-service substation condition assessment.



### EASY-TO-APPLY SUBSTATION CONDITION ASSESSMENT

Acoustic partial discharge measurements can be easily applied on gas-insulated switchgear and other high voltage equipment without the need of interrupting the operation. Such on-line measurements help to identify internal imperfections of the insulation system, which may lead to breakdown and system failure in the future.

Acoustic partial discharge measurements rely on the close acoustic contact of the area producing the discharge to the point of access, where the sensor is placed. Most of the partial discharge activity in GIS offer such a good contact and, hence, can be detected at a good sensitivity. Therefore, discharges from sharp points or cones as well as discharge activity from delaminations

can be identified at a sensitivity, which is mostly comparable to the conventional electrical detection according to the IEC 60270.

For some defect types, such as the so-called hopping or bouncing particles, the acoustic detection is by far superior to the electrical detection.

The AICompact offers automatic detection of the used sensor or preamplifier. Usually, the instrument is operated with acoustic sensors with remote supplied embedded preamplifiers directly connected to the signal input. Alternatively, the RPA1F can be inserted close to the sensor to boost the signal, in case longer signal cables are used or in case of low-level measurements.

UHF measurements on embedded or external sensors are possible with the use of the FCU2, a logarithmic frequency converter, which covers 100 MHz to 1800 MHz. As with the preamplifiers, the AICompact automatically detects the FCU2 and changes into the logarithmic display for the UHF detection. To protect the instrument's hardware it is advisable to connect an input protection unit like IPU2B to the sensor's output.

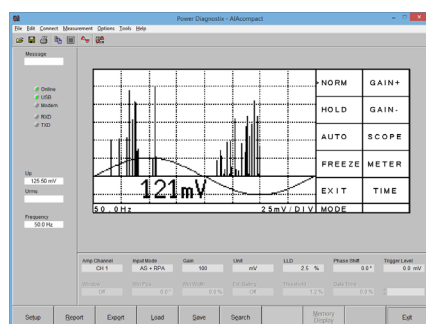

AICompact software in SCOPE mode

### DISPLAY MODES

In **SCOPE** mode, the AICompact shows the phase-resolved partial discharge signal or pattern. Here, the 'Freeze' function allows keeping such a captured pattern for further evaluation or for taking screenshots.

The **METER** mode offers four bar graph displays showing derived quantities of the captured activity. The graphs display the RMS and the peak PD level, as well as their 50 Hz (60 Hz) and 100 Hz (120 Hz) content. The instrument automatically synchronises to the line frequency.

Within the **TIME** mode, the AICompact displays five or ten AC cycles triggered by a partial discharge event. Thus, this display shows the pattern of consecutive partial discharge events and, hence, offers a clear identification of bouncing particles and the severity of their activity.

### OPTIONS

- AICompact software: All captured patterns and displays can be transferred to a notebook via an USB interface using the optional AICompact software. Furthermore, the software allows acquisition of coloured PD patterns.
- MUX12: Every AICompact comes with a four-channel multiplexer to split the PD signal and the voltage signal, with individual setup and calibration factor for each channel. On customer request, we also deliver the device with a 12-channel-multiplexer.

# TDAcompact Loss factor analyser

The TDAcompact is a portable capacitance and tan delta analyser. The focus of the instrument's application is on the analysis of the epoxy-mica insulation of rotating machines. Besides this, the unit is applicable for oil-paper insulation systems and especially for mass-impregnated cables.



## DISSIPATION FACTOR ANALYSIS

Analysing the dissipation factor (tan delta) is a traditional method to assess the condition of an insulation system. With the analysis of the dissipation factor, emphasis is more put on the overall health of the insulation system, whereas with partial discharge analysis, the focus is on individual defects producing discharge activity. Therefore, the application of tan delta measurements concentrates on insulation systems, which are relatively stable against partial discharge.

Most prominently, the health of an epoxy-mica insulation of a rotating machine can be assessed using a tan delta analyser. Especially, the presence of humidity within the winding, the surface contamination of field grading elements, or the polarisation losses of improperly cured resin, can be detected. Thus, the tan delta analysis is still a good complement to the partial discharge testing.

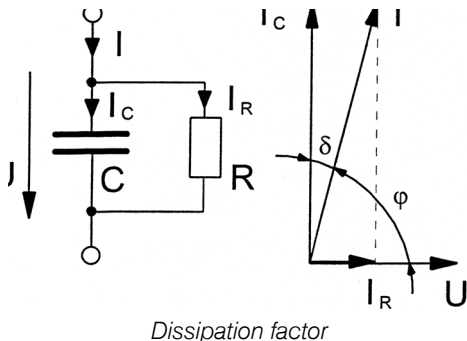

## PRINCIPLE OF OPERATION

The TDAcompact simultaneously samples the AC current drawn by the device under test and the current drawn by a reference capacitor. Subsequently, the two current traces are evaluated and the capacitance, the tan delta, and the level of the high voltage are calculated. The unit continuously displays and refreshes these results.

Therefore, the instrument does not require any user interaction as with the traditional Schering Bridge, nor does the refresh of the display take that long as with automatic adjusting bridge-type analysers. The basic resolution of the tan delta measurement is  $10^{-4}$ , which fulfils the requirements for rotating machine testing as well as for testing on mass-impregnated cables.

## MODULAR CONCEPT

Besides the stand-alone field test application of the TDAcompact, the instrument can also become a part of a larger and automated test system. Using the software HVpilot, the instrument will be read according to a pre-programmed test sequence. Besides tan delta measurements, such automated test systems further include partial discharge measurements and so-called step tests.

## STAND-ALONE INSTRUMENT

The TDAcompact is designed as a stand-alone instrument. To measure the two currents the basic configuration of the TDAcompact comes with a standard capacitor, that has a built-in shunt capacitor, in combination with an external shunt. Optionally, the unit can be supplied with further shunt capacitors.

Generally, the TDAcompact is with digital fiber-optic links to the precision shunts, which allow operation on any potential including the high voltage connection of the device under test. The measuring frequency can vary between 20 and 500 Hz. Upon request, Power Diagnostix can supply complete portable tan delta testers including the high voltage transformer.



TDAcompact with combined reference and shunt capacitor RC30/SC5B as well as fibre optic transmitter FOT2C



# FOsystem

## Fibre optic transmission systems

The FOsystem is a complete set of instruments for convenient fibre optic transmission of different types of signals from a variety of sensors. The FOsystem means simple integration into existing measuring system and allows easy implementation of fibre optic transmission to solve noise, safety, and signal quality issues in high voltage measuring environments and other demanding conditions.



FOsystem with eight channels

### FIBER OPTIC VS. WIRING

Although differential and isolation amplifiers can eliminate some of the many possible sources of error and at least reduce their effects, only fibre optic isolation amplifiers bring definite relief. Optical isolation of measuring circuits eliminates long measuring cables prone to electromagnetic interference, and potential differences of several hundred kilovolts become possible between measuring and recording circuits.

Applying fibre optic isolation with high impulse-current applications allows the ground potential to have dramatically transient changes without affecting the integrity of the signals captured and transmitted.

Besides these intrinsic advantages of optical transmission, the FOsystem by Power Diagnostix means simple integration into existing measuring systems and low electromagnetic interference even under difficult measuring conditions, thanks to the use of metal-clad and very compact transmitter equipment. In many cases, miniature transmitters designed on SMD principles can even be integrated into the measuring object.



Fibre optic transmitter FOT1 with options S4 and S6



Acoustic sensor

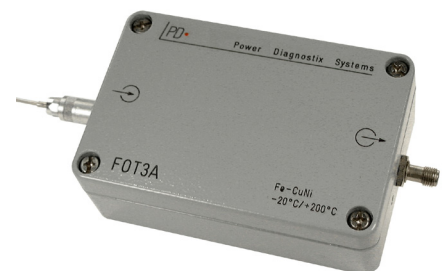

Transmitter unit FOT3A

### SYSTEM VARIANTS

The FOsystem is a set of instruments consisting of transmission units, receiver units, and sturdy fibre optic cables for convenient fibre optic transmission of different types of analogue signals from a variety of sensors. The FOsystem allows easy implementation of fibre optic transmission to solve noise, safety, and signal quality issues in high voltage measuring environments and other demanding conditions.

The Power Diagnostix FOsystem comes in several basic variants, for each of four signal types:

- **FOS1** for analogue transmission of analogue signals from DC up to 10 MHz
- **FOS2** for digital transmission of analogue signals from DC up to 20 kHz
- **FOS3** for pulsed digital transmission of slowly changing signals, such as temperatures.
- **FOS4** for digital transmission of analogue signals from DC up to 65 MS/s

The fibre optic transmitter modules (FOT) are small individual modules for installation at sensors or signal sources. The fibre optic receiver modules (FOR) are mounted side-by-side in a 19-inch or half 19-inch rack and, thus, can be combined to multi-channel measuring systems..

# Fibre optic transmission systems

## OPERATION

The output signal of the signal source or sensor (for example, voltage, dynamic pressure, current, or partial discharge) is fed to the input of the battery-operated fibre optic transmitter FOT. The transmitter then either converts the pre-processed analogue signals into a serial 12-bit signal with 100 kHz sampling rate, which modulates the infrared light emitted by the transmitter diode according to the value of the input signal, or digitises the signal and transmits a digital telegram. This digitally modulated light is transmitted via the optical fibre to the receiver, which converts the optical signals back to voltages ( $\pm 10$  V) for further processing. An insufficient optical level (violation of the upper or lower limit of the dynamic range) is detected and indicated.

## TRANSMITTER

The transmitter is installed in a cast aluminium enclosure. The FOT is fitted with a NiMH-battery for a minimum operating time of twenty hours (FOT1 and FOT2), whereas the FOT3 offers up to two years of operation while sending a telegram every five seconds.

Transmitters are available in different variants, including, for instance, versions for adjustment to piezoelectric pressure transducers or displacement/position transducers. Besides these options, the units can be fitted with customer-specific circuits for adjustment to further sensors. We use a robust optical fibre type which features a very small influence of mechanical loads on its attenuation parameters.

TYPE	OPTION	FOS1	FOS2	FOS3	FOS4
FOT1	Analogue transmitter 0.2 Hz to 5 MHz (-3 dB)	X			
FOT2	Digital transmitter 0 to 20 kHz (-3 dB)		X		
FOT3A	Transmitter for temperature measurement			X	
FOT3B	Transmitter for voltage and current			X	
FOT4A	Digital transmitter up to 20 MS/s, (0.2-2 MHz bandwidth)				X
FOT/S2	Pressure measurement	X			
FOT/S3	Fixed DC coupling	X	X		X
FOT/S4	Switched DC coupling	X	X		
FOT/S6	Remote activation	X			X
FOT/S7	Special input range	X	X		X
FOT/S8	Pressure measurement (Kistler 6203 sensor)	X			
FOT/S9	Displacement measurement	X			
FOT/S10	Bandwidth 10 MHz	X			
FOT/S12	Ultrasonic measurement	X			X
FOT/S14	EMC enclosure			X	X
FOT/S15	Additional BNC connector for external power supply	X	X	X	X
FOT/S16	Pressure measurement (Kistler 4043A sensor)	X			
FOR1	Receiver plugin 0.2 Hz to 5 MHz	X			
FOR2	Receiver plugin 0 to 20 kHz		X		
FOR3	Receiver plugin FOR3			X	
FOR4	Receiver plugin up to 65 MS/s, (30 kHz bandwidth)				X
FOR/E2	DC coupling, track/hold switch	X			
FOR/E3	DC coupling, adjust button	X			
FOR/E5	1.2 inch width, output on rear side	X	X		
FOR/E6	Bandwidth 10 MHz	X			
FOR/E7	Bandwidth limit 1 MHz, noise reduction	X			
FOR/E8	Single-channel remote transmitter	X			



# FOS4 Fiber optic transmission system



The latest family member of Power Diagnostix's fibre optic transmission systems, FOS4, offers high speed data acquisition via fibre optic cables on multiple channels in parallel. The scalable system allows the acquisition of acoustic PD signals or other measurement signals under AC, DC, or during impulse testing in laboratories as well as on-site. The modular system accepts up to 12 optical channels and comes with high-speed controller card to communicate with a notebook. Besides this, the FOS4 system has additional signal output on the rear side and can be used as a digital isolated amplifier without the use of any software.

## ICMacoustic SOFTWARE

The ICMacoustic software offers full control of the FOS4 system including averaging and trigger logic. It is designed for the acoustic location of transformer partial discharge with the triangulation method. The basic idea is to reduce the location to a 'flat problem'. I.e., to horizontally position three sensors on a line to firstly get the horizontal position of the layer (see upper graph of the software's measurement panel, left). Here, the position of the sensors are entered and assigned to their channel. In a second step the sensors are placed on a vertical line at the found vertical position. In the lower graphs the sensor positions are entered accordingly.

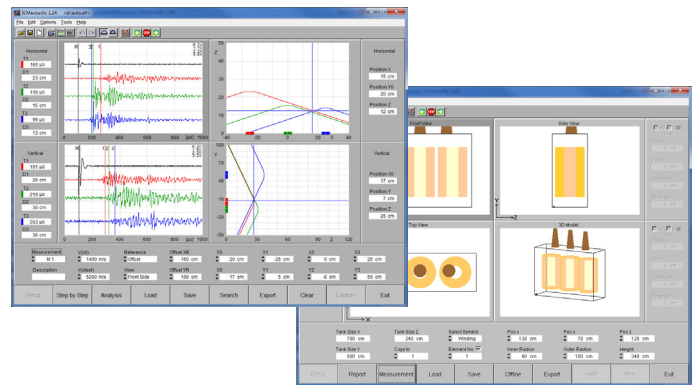

## APPLICATION EXAMPLE

### PD location by acoustic travel time analysis

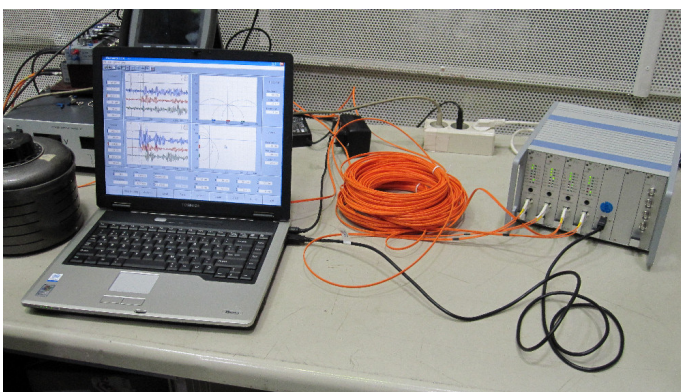

The ICMacoustic system consists of FOT4 transmitter units and FOR4D receiver units. Each channel acts as an independent transient recorder with its own storage and settable acquisition speed and storage depth. The sampling rate is 20 MSamples/sec. and, hence, sufficient to even acquire the pointing vector of the incoming acoustic wave, when using a two-dimensional three-sensor configuration.

## FEATURES

- Sampling rate: 20 MS/s
- Up to 12 receiver units with independent optical channels
- Remote controlled via high speed USB port



FOS4 with eight channels

## CAL1, CAL2, CAL3 series Calibration impulse generators

Partial discharge measurement is a useful tool to analyse the insulation of high voltage components. However, partial discharges can usually not be measured directly, just the apparent charge of such signals are captured by the measuring instrument. Therefore a calibration of the whole measuring system is required in principle. Hereby short-duration current pulses of known charge magnitude are injected into the system, and by this a scale factor can be calculated for later PD measurements.

Power Diagnostix offers a wide range of calibration charge injectors suitable for use in calibrating partial discharge measurements. The appropriate choice of a calibration instrument depends on the range of typical charge values of the PDs being measured. Calibrators can also be used for time domain reflectometry in cables to determine cable length and location of joints.

Power Diagnostix calibrators enjoy all the advantages of 20 years' experience in calibration services. The broad range of easy-to-use and robust units for many different applications ensures reliable PD measurements compliant to international standards, such as IEC 60270, CISPR 18-2 and NEMA 107-1987 (CAL3A/B).



### INTERNATIONAL STANDARDS CONFORMITY

Power Diagnostix operates a calibration laboratory, which has received the accreditation within the German Calibration Service DKD by 2003. In January 2012, Power Diagnostix passed over to the newly introduced German accreditation authority DAkKS (DAkKS = Deutsche Akkreditierungsstelle). Power Diagnostix's new accreditation is filed under D-K-15068-01-00. The audit according to ISO 17025:2018 was held by 'Physikalisch Technische Bundesanstalt' PTB, the German authority of standards.

New calibrators are shipped with the calibration certificate to ensure the traceability to international standards.

### SIMPLE TO USE

The calibrator is switched on with the button On/Off. Both amplitude (Range) and polarity (Pos/Neg) of the single charge pulse per cycle are displayed and can be adjusted by pressing of the two buttons. Each calibrator is also available supplying two pulses per cycle, as well as with double impulse output with adjustable interval. The instrument automatically synchronises to line frequency by a photo diode. In case of insufficient pick-up of power frequency light, the calibrator automatically selects the internal quartz oscillator (50 Hz and 60 Hz versions available).

### UNIQUE CONCEPT

The Power Diagnostix line of calibration impulse generators is unique in that the charge pulse is generated by injecting a variable voltage step (correlated to an internal reference) via a fixed capacitor. This injection capacitor is relatively small, as the step voltage amounts up to 120 V for full range output. Therefore, the Power Diagnostix calibrators offer excellent impulse properties. Further, calculation of the correction factor is usually not necessary ( $C_i \ll C_s$ ).

### AVAILABLE CALIBRATORS

The standard calibration impulse generator CAL1A offers the charge range of 1/2/5/10/20/50/100 pC, while the CAL1B, mainly suitable for rotating machinery testing, covers the range of 0.1/0.2/0.5/1/2/5/10 nC.

Special signal sources are available for GIS measurements, such as the CAL2B with voltage output: 2/5/10/20/30/40/50 V,  $R_L = 50 \Omega$ ,  $t_r \leq 200$  ps,  $t_f = 100$  ns.

For calibrations on RIV measurements, signal generators like the CAL3A are available. The CAL3A offers a continuous sine wave voltage signal of 600 kHz to 1350 kHz, adjustable in steps of 50 kHz. Available voltage steps are 10/20/50/100/200/500  $\mu$ V/1/2/5/10 mV. In burst mode, the output signal is switched on during half of the power frequency cycle – versions for 50 Hz and 60 Hz are available.



# RIVmeter

## Radio influence voltage meter



The RIVmeter is an instrument for the measurement of radio influence voltage (RIV) according to the relevant standards (NEMA 107-1987, IEC CISPR 18-2:2010, EANSI 63-2-1996, VDE 876, DIN EN 55016-1-1). The instrument has a bandwidth of 9 kHz and a tunable center frequency of 100 kHz to 2 MHz. Technically, the RIVmeter is a selective  $\mu\text{V}$ -meter. However, the meter reading is weighted according to the CISPR weighting curve, whereas the repetition rate has a strong impact on the reading. The RIVmeter is an ideal instrument to replace outdated RIV measurement instruments in a transformer testing lab, for instance.

### RIV MEASUREMENTS

Some routine PD measurements are still done according to IEEE standards requiring the measurement of radio influence voltage. The RIV value is given in  $\mu\text{V}$  (interference voltage). A narrow band filter performs a quasi-integration of the PD pulses with a quasi-peak detection at the centre frequency. This centre frequency can be adjusted between 100 kHz and 2 MHz. The narrow-band pass filter allows to suppress external noise, e.g., in non-shielded laboratories by varying the centre frequency of the filter.

Two factors determine the RIV in  $\mu\text{V}$ : the transferred charge and the repetition rate of the PD impulse (number of PD pulses per second). Because of this proceeding, a direct translation of the measured RIV values ( $\mu\text{V}$ ) into values of apparent charge in pC is not possible.

Historically, the RIV technique is based on measurement receivers to estimate the disturbance of communication

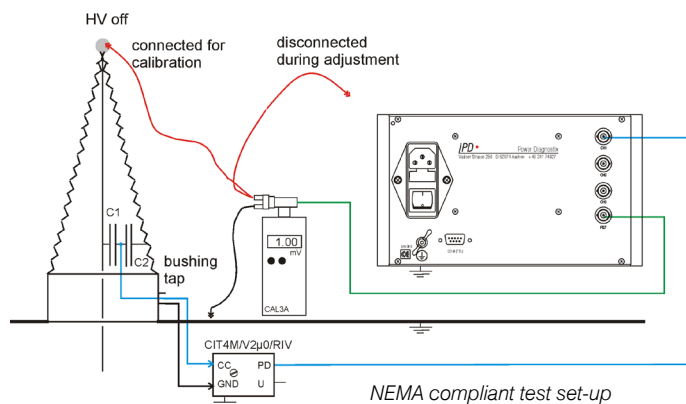

lines. Thus, properties of those instruments then available became part of the NEMA standards. However, both the 9 kHz bandwidth and the CISPR weighting curve put emphasis on some partial discharge activity, while they tend hiding others.

### CALIBRATION

The calibration of the RIV measurement is done using an RIV calibrator, injecting a sine wave of typically  $100 \mu\text{V}$  into the bushing. The multiplexer of the RIVmeter is used to conveniently determine the correction factor according to NEMA 107-1987 and other standards. Here, the unit compares the voltage injected, i.e., loaded by the bushing's impedance, with the voltage detected at the bushing tap to automatically determine the k-factor. This correction factor is then stored independently for each channel during calibration.

The standard calibrator for RIV calibration, CAL3A, offers a selectable frequency range of 600 to 1350 kHz in steps of 50 kHz. The output voltage covers  $10 \mu\text{V}$  to 10 mV in 1-2-5 steps. The CAL3B calibrator offers a frequency range of 400 kHz to 1.9 MHz with the same output voltage but in steps of 100 kHz. Having the same frequency range as the CAL3B, the CAL3D comes in contrast with a high impedance output ( $> 20 \text{ k}\Omega$ ) according to IEC CISPR 18.2:2010.



CAL3A and CAL3D

# HVcompact High voltage meter



The HVcompact is a high voltage meter with an auto-ranging oscilloscope display of the voltage waveform. The unit displays  $\hat{U}$ ,  $\hat{U}/\sqrt{2}$ ,  $U_{rms}$ , frequency, and the crest factor. To improve the readability, one selected measurement is displayed using larger characters. To protect test specimens, the unit offers a pre-settable voltage limit, which trips a relay output. The divider ratio is widely adjustable and is kept with a non-volatile memory.

Mostly, the HVcompact is used in case of modernisation or upgrade of high voltage test sets. With conventional analogue or digital panel meters, usually, solely the voltage is displayed. The HVcompact adds several helpful functions.

## OSCILLOSCOPIC DISPLAY

The input voltage is sampled in high resolution and one cycle is displayed as an oscilloscopic trace. Any distortion of the high voltage due to transformer core saturation or power frequency harmonics, for instance, are clearly identified with this display. The screen is automatically synchronised with the measured voltage and the amplitude deflection is controlled by an auto-range function.

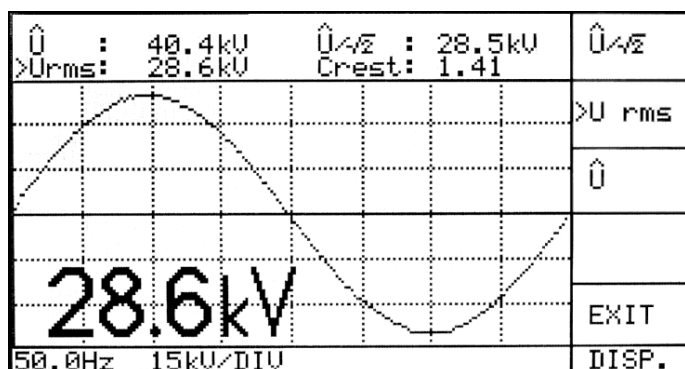

## MEASUREMENTS

Usually, the instrument connects to capacitive or resistive divider. With larger high voltage transformers, the capacitance of the condenser bushing can be used. Within the menu of the HVcompact the divider ratio can be adjusted. It is kept with a non-volatile memory. The nominal input range of the HVcompact is 100  $V_{rms}$ . In order to cover correctly even strong harmonics, peak voltages of up to 200 V are accepted and sampled.

Using the sampled voltage, the instrument calculates based on the preset divider ratio the characteristic quantities of the high voltage signal. With the upper two lines of the display the peak voltage  $\hat{U}$ , the peak voltage divided by the square root of two  $\hat{U}/\sqrt{2}$ , and the effective voltage  $U_{rms}$  is shown. Additionally, the crest factor is calculated and displayed. With the bottom line of the display, the frequency of the captured voltage signal is shown. This bottom line further shows the scaling of the Y-axis grid of the oscilloscopic display. One selected value is displayed using larger characters for improved readability.

## SAFETY FEATURES

A voltage limit can be set with the instrument in order to avoid that a test specimen is stressed above its allowable voltage. In case the voltage then exceeds this limit, a relay is tripped. This relay can be used to block the 'UP' button of the control circuit or to disconnect the main circuit breaker.

Additionally, the instrument detects incipient breakdown or flashover. Therefore, a maximum permissible voltage change per second ( $dU/dt$ ) can be set. Each individual cycle of the high voltage signal is analysed. Especially with long-term voltage endurance tests, this feature can minimise the thermal destruction of the breakdown channel and, thus, improves the analysis of the defect.

## OPTIONAL RECORDER OUTPUT

The HVcompact is available with an optional recorder output (REC OUT). In case, a connector carries a re-converted analogue (DC) signal of up to 10 V, which corresponds to the high voltage signal. This signal can be fed to a paper recorder, for instance. A screw terminal carries the optional relay output signals for voltage limit and breakdown detection.

## READY-TO-USE CALIBRATED

Every HVcompact is delivered with a fully traceable calibration according to the standards of the German accreditation authority DAkkS (DAkkS = Deutsche Akkreditierungsstelle). Power Diagnostix's accreditation is filed under D-K-15068-01-00.

On order the HVcompact can be calibrated on-site together with its divider impedance.





# STEPcompact

## Step voltage test controller

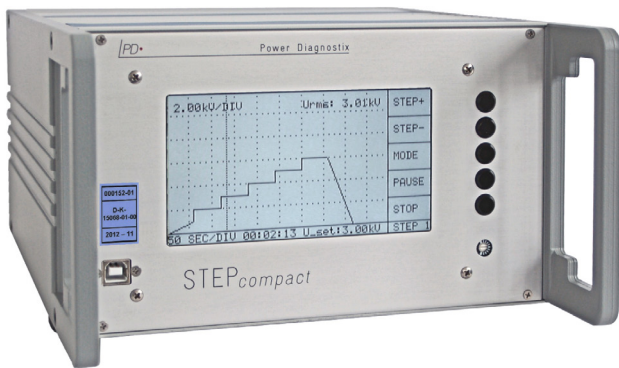

### FEATURES

Similar to the HVcompact, the instrument calculates and displays the characteristics of the captured high voltage signal, such as  $\hat{U}$ ,  $\hat{U}/\hat{O}_2$ ,  $U_{rms}$ , frequency, and the crest factor. The unit accepts a nominal input voltage of 100  $V_{rms}$ . In order to correctly acquire even excessively distorted high voltage signals, the STEPcompact samples up to 200 V peak signals.

Using the five menu-driven control buttons, up to 35 different test sequences can be programmed and stored in a non-volatile memory. A test sequence consists of steps and ramps in any order. Besides the automatic mode, a manual mode can be used to set a specific voltage and keep it over time. In factory environments with strongly varying load situations, this function can be very helpful to maintain a stable high voltage level with long-term tests.

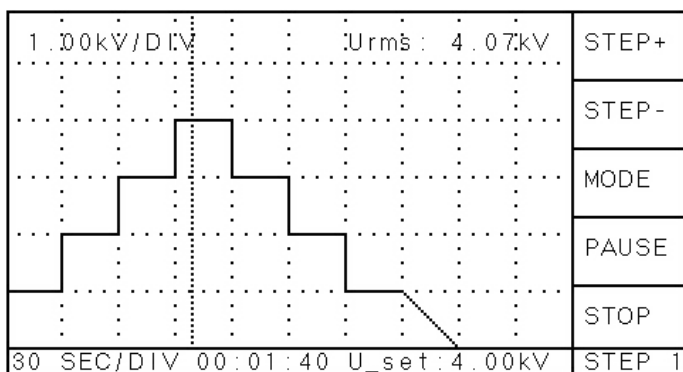

Running step test sequence

Up to seven configurations can be stored in the non-volatile memory in order to adapt the instrument to the properties of different high voltage test sets. Besides the divider ratio, a configuration setup contains settings, such as the control cycle or the control window to tune the instrument to the properties of the high voltage test set.

Increasing the high voltage stepwise is a task that is often required during type testing and production testing of high voltage products. The STEPcompact is an instrument to automate such step tests. The unit combines the control function with the measurement capabilities of a high voltage meter. As a stand-alone instrument, the STEPcompact can be easily moved between different high voltage test sets.

The STEPcompact measures the voltage signal derived from a capacitive or resistive divider. Using a fiber optic transmission, the UP and DOWN relay contacts of the voltage regulator are actuated to adjust the high voltage according to the programmed test sequence.

In the standard configuration, the STEPcompact comes with a self-contained relay box that is remotely controlled via a fibre optic cable. Alternatively, a direct connection to the HVcontrol, Power Diagnostix standard control unit for high voltage test sets, can be provided.

To ensure a safe unattended processing of a step test, the STEPcompact offers several safety features. Incipient breakdown is detected by monitoring the change of the voltage ( $dU/dt$ ). Further, timeout limits can be set. The instrument keeps a record of the recent test to validate its successful completion or to indicate the point of breakdown or cancellation.

### HVpilot SOFTWARE

The HVpilot software allows the complete supervision of a high voltage test sequence. Using a serial interface, the software connects to the STEPcompact for the voltage control and measurement. Further, the HVpilot software offers convenient programming and editing of the test sequences. Additionally, this software can connect to the ICMcompact to read the partial discharge level and to the TDAcompact to read the tan delta, as well as the capacitance of the device under test. An export function allows to save the acquired data in file formats for MS Excel and MS Word.

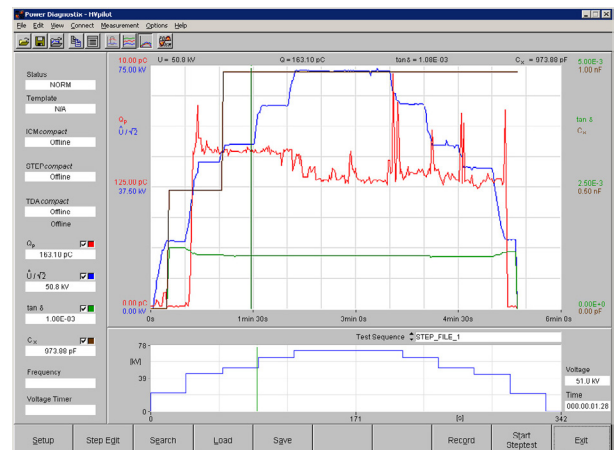

# HVcontrol High voltage test control unit

The HVcontrol unit combines all standard functions required to manually operate a high voltage transformer. It includes a safety contact loop, the measurement of primary and secondary current, as well as of the primary voltage. User-settable limits for the primary and secondary current trip the main circuit breaker. The safety loop, as well as the emergency stop is hard-wired and equipped with forced contacts.

## EASY INTEGRATION

Due to its flexible design, the HVcontrol can be used on any high voltage test set. Especially, in case of the modernisation of old test sets, the HVcontrol offers a multitude of improvements if compared with conventional relay based controls.

The unit comes with rigid solid-state piezo push buttons. Each of these control buttons has an illuminated ring to indicate the state of the function controlled by this specific button. This allows an easy and intuitive operation of the HVcontrol.

The HVcontrol offers an output for TTL gating and a SCOPE display and comes in a 19-inch subrack (3 HU). This makes it an easy replacement of older controls having the same size. On its rear panel, the HVcontrol offers conveniently detachable screw terminals for the different controls and optional instruments.

## MODULAR CONCEPT

Besides a mere drop-in replacement of an old control, the HVcontrol can be combined with other test instruments of Power Diagnostix to build a fully automated acceptance test environment.

The instrument can be combined with the ICMcompact for partial discharge testing and with the TDAcompact for tan delta and capacitance measurements.

Power Diagnostix also provides industrial PCs to control the combination of instruments. Depending on the application and its requirements, the instruments can be mounted in desktop enclosures, 19-inch racks, or control desks fitted with 19-inch mounts.

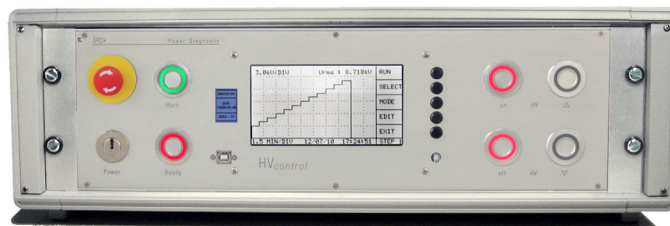
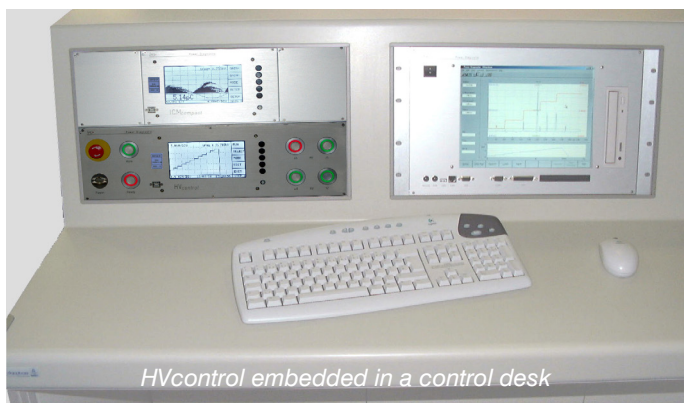

## STEP TESTS

### Optional feature

Increasing the high voltage stepwise is a task that is often required during type testing and production testing of high voltage products. The HVcontrol can be ordered with an optional feature to automate such step tests.

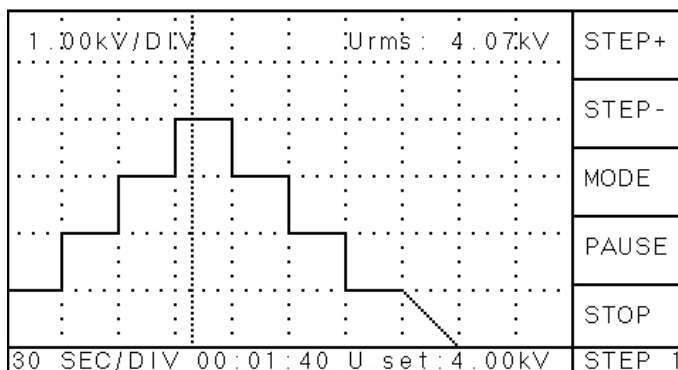

### HVpilot software

The HVpilot software allows the complete supervision of a high voltage test sequence if the HVcontrol is equipped with the option for step tests (voltage control and measurement). Further, the HVpilot software offers convenient programming and editing of the test sequences. Additionally, this software can connect to an ICMcompact to read the partial discharge level and to a TDAcompact to read the tan delta as well as the capacitance of the device under test.

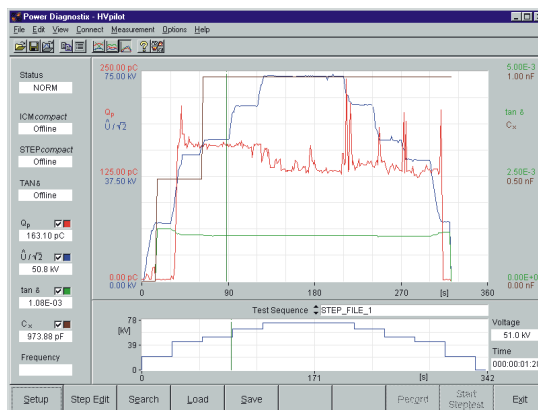



## HVTC and TCU

### HV test chambers and transformer control units

The high voltage test chamber HVTC is designed for PD testing on e. g. transformers, semiconductors, and micro samples. Depending on the built-in HV transformer, testing up to 20 kV<sub>rms</sub> is possible. The test chamber provides sufficient space to test samples up to a maximum size of 500x500x400 mm<sup>3</sup>. The main components of this system are a high voltage transformer, a regulating transformer, a coupling capacitor of 1 nF, an automatic grounding system, a security interlock loop, and multiple warning lamps.

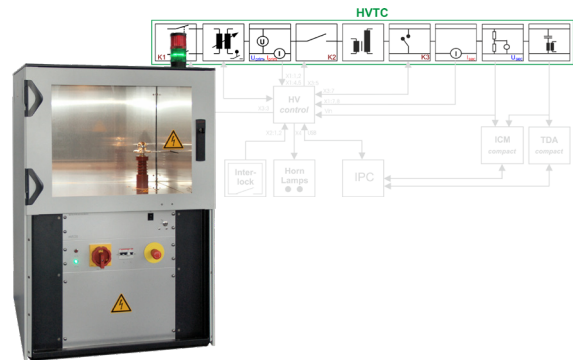

### CUSTOMISED SOLUTIONS

Beside solutions for the standard range of applications we provide customised solutions for special test applications. In the past we designed PD measurement test benches for special tasks, such as PD test cabinets for insulation foils of solar panels or PD test cabinets for heating pumps and small motors.

Partial discharge occurring in insulating materials can cause long-term damage of the material when exposed to high voltage stresses. Partial discharge testing can detect voids or imperfections in insulators and, hence, helps to prevent overheating and breakdown under normal operating conditions. Since PD signals are susceptible to electronic and radio frequency noise, corona-free and properly isolated test chambers are of high importance for such tests. Those chambers can be used in development, production, and quality assurance for non-destructive isolation and quality tests of electric components, such as:

- Electronic components
- Insulation materials
- Capacitors
- Transformers
- Switches
- Arrestors
- Cable and wire samples
- Insulated-gate bipolar transistor (IGBT)
- Semi conductors
- Micro samples

Power Diagnostix's high voltage test chambers HVTC are suitable for PD tests according to international standards. Depending on the built-in HV transformer, testing up to 20 V<sub>rms</sub> is possible.

The main components of this system are: A high voltage transformer, a regulating transformer, a coupling capacitor of 1 nF, an automatic grounding system, a security interlock loop, and multiple warning lamps.

Beside solutions for the standard range of applications we provide customised solutions for special test applications. In the past we designed PD measurement test benches for special tasks, such as PD test cabinets for insulation foils of solar panels or PD test cabinets for heating pumps and small motors.



Combination of HVTC20 and a climat chamber

### TRANSFORMER CONTROL UNIT TCU

Power Diagnostix's TCU is made for controlling of high voltage transformers. Together with the HVcontrol it combines all standard functions required to manually or automatically operate a high voltage transformer, including safety loops, door locks, and all voltage and current measurements. The transformer control unit comes in a moveable 19-inch rack and includes a built-in regulating transformer. The delivery range of the TCU includes a warning lamp and a built-in horn.



# HVTC and TCU

## HV test chambers and transformer control units

TYPE	VOLTAGE	POWER	CURRENT	CONNECTION	HEIGHT	DIMENSIONS W X H X D
TCU3	0 to 230 V	3 kVA	16 A <sub>max</sub>	CEE 400/16A (L-N)	9 HU	553 x 506 x 600 mm <sup>3</sup>
TCU7.5	0 to 230 V	7.5 kVA	34 A <sub>max</sub>	CEE 400/32A (L-N)	9 HU	553 x 506 x 600 mm <sup>3</sup>
TCU10	0 to 230 V	10 kVA	48 A <sub>max</sub>	CEE 400/63A (L-N)	9 HU	553 x 506 x 600 mm <sup>3</sup>
TCU10/2	0 to 400 V	10 kVA	25 A <sub>max</sub>	CEE 400/63A (L1-L2)	9 HU	553 x 506 x 600 mm <sup>3</sup>
TCU15/2	0 to 400 V	15 kVA	38 A <sub>max</sub>	CEE 400/63A (L1-L2)	25 HU	553 x 1218 x 600 mm <sup>3</sup>
TCU25/2	0 to 400 V	25 kVA	34 A <sub>max</sub>	CEE 400/63A (L1-L2)	34 HU	556 x 1627 x 600 mm <sup>3</sup>

### MODULAR CONCEPT

Partial discharge testing – well established for high voltage equipment – becomes increasingly important for insulation systems of a lower voltage level. Changing to switching power supply and to IGBT control of induction motors, for instance, raise demands and testing needs for the insulation system. The modular concept of Power Diagnostix's instruments allows offering customised solutions for automated and semi-automated testing.

Different levels of automation can be provided depending on the testing needs. In case of full production testing a high level of automation and simple go/no go decision are needed, whereas manual control offers a higher level of flexibility when testing samples or sample variants during development.

Generally, such test arrangements consist of a test chamber and instruments to control and measure voltage and partial discharge. Different levels of automation are offered combining the basic *HVcompact* for voltage measurement with the *HVcontrol* for regulating the HV transformer and for programming voltage steps, ramps, or more complex functions. Installed on an industrial PC, the *HVpilot* software then optionally controls these instruments, and the *ICMcompact* for the PD signal and automatically prepares the test report. Additionally, Power Diagnostix designs special test fixtures, dual test chambers for increased performance, and customer specific software.

Depending on the needs the instruments and controls can be compiled in different versions:

#### Level A

PD test bench for sample testing consisting of a test chamber and manual voltage control equipped with an *ICMcompact* for PD measurement with voltage option or an *HVcompact* for voltage measurement.

#### Level B

As level A, but instead of the *HVcompact* with the *HVcontrol* for automated voltage control.

#### Level C

As above, but with an industrial PC and the *HVpilot* software for fully automated control and test report generation.

#### Level D

Modernisation of test rooms using *HVcontrol*, *HVcompact* or *STEPcompact*, and *ICMcompact*. Software control as with level C.

### TYPICAL PACKAGE

#### Test set-up for level C:

- 1 x *ICMcompact* with gating function
- 1 x *HVcontrol* with STEP functionality, 19-inch rack
- 1 x Test chamber HVTC, incl. 10 kV voltage transformer, regulator, manual control buttons, horn, lamps, emergency stop, grounding system, coupling capacitor, ...
- 1 x Industrial PC
- 1 x Software *ICMcompact*
- 1 x Impulse calibrator CAL1A
- 1 x Preamplifier RPA1
- 1 x Set of cables



Typical test set-up for level C



## PRPDreplay

# PD pattern sequence and synchronisation signal generator



The PRPDreplay is a portable pattern sequence and synchronisation signal generator. It allows the replay of partial discharge data sets recorded and stored with Power Diagnostix instruments, such as the ICMsystem, ICMcompact, ICMmonitor, etc. It provides the analogue signals of the PD pulses and of the synchronisation voltage for further processing. Raw data can be imported via USB port from DAT, DTC, or DT2 files.

The device is battery operated and comes with a set of default phase-resolved partial discharge patterns.

## FEATURES

- Intuitive touch display operation
- Robust Explorer case
- Battery driven (up to eight hours continuous operation)
- Fully operational even while charging
- Ability to load customer supplied pattern from USB storage
- 2x12-bit D/A converter
- Embedded software
- Set of typical PD patterns included

Compact design and easy handling make the PRPDreplay the ideal solution for:

- Research, education, and training
- Off-line PD signal simulation
- Sensitivity and PD device checks
- AI training purposes

## SIX REASONS FOR THE PRPDreplay

- **Compact** - Easy to handle
- **User-friendly** - Intuitive touch display operation
- **Stand-alone** - No accessories needed
- **Independent** - Battery operated
- **Portable** - Fits even in cabin baggage
- **Robust** - Rugged enclosure



*Replay display of the PRPDreplay*

# ATTanalyzer

## Acoustic breakdown locator

The Power Diagnostix ATTanalyzer is a simple and effective stand-alone tool to aid in commissioning tests of gas-insulated switchgear (GIS) systems and power transformers. The ATTanalyzer reduces delays in commissioning and maintenance by locating flaws in GIS systems and transformers acoustically.

### REDUCING BREAKDOWN RISKS

Gas-insulated switchgear systems occasionally contain flaws that go unnoticed during installation or maintenance but that lead to immediate breakdown when high voltage is applied. These flaws can include floating particles, gaseous impurities, faulty insulator discs, sharp metal burrs, or other defects. If a gas-insulated switchgear system contains such a flaw when brought on-line, sparking and breakdown occurs at the flaw, forcing de-energisation and repair. Without diagnostic aids, location of the flaw can lead to costly delays and unnecessary opening of unflawed gas chambers bearing the risk of causing new imperfections, while searching for the chamber containing the flaw.

Using the ATTanalyzer, the flaw can be located by mounting acoustic sensors to the outside of the GIS or transformer tank in several locations. When high voltage is applied to the GIS, if a breakdown occurs, the acoustic sensors pick up the disturbance and transmit a corresponding optical signal to the ATTanalyzer acquisition unit. The ATTanalyzer then compares the relative travel times of the sound signals to determine which sensor is the closest to the flaw.

Following initial location of the breakdown's origin, the acoustic sensors can optionally be repositioned closer to the flaw to narrow the location further, to within a few centimetres. Comparing the resulting display with the display of the breakdown while using a hammer to trigger a similar pattern on the ATTanalyzer, further helps to narrow down the location of the flaw.

### SYSTEM COMPONENTS

The ATTanalyzer consists of a compact central acquisition unit, acoustic sensors, and sturdy fibre optic cable to connect the sensors to the acquisition unit.

The stand-alone ATTanalyzer acquisition unit, mounted in a half 19-inch rack, receives and internally processes signals picked up by the sensors. The acoustic sensors for external mounting on the GIS system can be easily attached and removed for reuse. Up to sixteen sensors can be connected to the ATTanalyzer.

Fibre optic cables, up to 200 metres in length, provide galvanically isolated connection of the sensors to the ATTanalyzer acquisition unit.



### OPERATING MODES

#### AUTO

This mode considers each trigger event. Thus, the instrument's memory contains the most recent 16 events.

#### NORM

Using this mode, the unit changes to the STOP mode after 16 events captured. Therefore, the memory contains the first 16 events.

#### SINGLE

This mode changes after each captured event into STOP mode. Changing manually back into RUN mode re-enables triggering.

### FEATURES

- The ATTanalyzer's embedded LCD panel displays the relative travel times from the sensors as horizontal bars. Cursors and settings are manipulated through buttons and on-screen menus.
- The display screen also shows relevant quantities, such as sampling rate, time between cursors, time and date stamp, etc.
- Using simple menus, users can adjust the sampling rate of the acquisition unit appropriately depending on how widely or closely spaced the sensors are to each other. The ATTanalyzer features storage of up to sixteen GIS fault events with time and date stamps. Users can choose one of three operating modes.





# Test vans and trucks

## Mobile HV AC test systems



On-site transformer testing is the main application of Power Diagnostix's mobile high voltage AC test system. However, it can be used as well for other on-site testing, such as of GIS, rotating machines, or high voltage cables.

It is designed for performing routine and special tests according to standards, such as IEC 60060-3, IEC 60076, and IEEE Std. C57.113-2010 and, thus, giving accurate and reliable test results as known from acceptance tests performed in a static test field of a factory.

### VERSATILITY

The system stays within the load and size limitations for permission-free road use. Additionally, the matching transformer and the reactor are filled with ester instead mineral oil. Thus, it can be easily transported to a substation, power plant, or other high voltage areas for testing HV components after installation or repair. Moreover, it is applicable for condition assessment and fault investigations. PD measurements can be performed in non-shielded environments as part of the on-site acceptance test on a power transformer, or as a method to locate PD failures acoustically or by electrical measurement.

### APPLICABLE TESTS

- Applied voltage tests in a resonant circuit up to a test level of 500 kV
- Induced voltage test (single- or three-phase) up to a test level of 90 kV.
- Electrical and acoustical partial discharge measurements
- Measurement of no load losses
- Heat run with up to 1.3 MVA

### MEASURING EQUIPMENT

- Eight-channel ICMsystem with spectrum analyser and PD calibrator
- Three-channel FOsystem (current measurement)
- Power analyser
- Three HV filters TVC100/123 with integrated voltage divider and current shunts
- DAkKS calibrated voltage and current measurement
- Quadrupoles, couplers, preamplifiers, calibrators, and further accessories are also included.

Main component of the mobile HV AC test system is a frequency converter based on the IGBT technology, that provides the power in a frequency range of 15 to 200 Hz. It consists of three identical converters that can be operated in parallel (0° phase shift) or as a three-phase system (120° phase shift). Thus, always the full power of the converter can be used. The system comes with an inductive and capacitive compensation, and with a step-up-transformer, that can be switched manually to different configurations. Disturbances from the power supply will be filtered by Power Diagnostix's T-filter TVC100/123. The special design of these filters allows current measurement on HV potential and voltage measurement from a capacitive divider. Both, current and voltage measurements, are DAkKS-calibrated and the precise values are displayed by a power analyser.

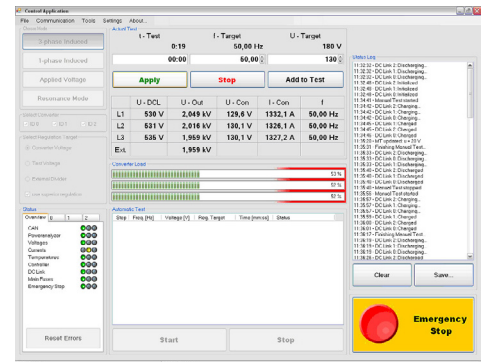

## ULTRASONIC PD SENSORS

### Acoustic sensors AS75I and AS150I

The AS75I and AS150I are active sensors with very high sensitivity for measurements on GIS, transformer tanks, or cable joints. They come with a built-in 40 dB preamplifier and can be connected to the RPA1D, RPA1F, RPA1G, or directly to the AIAcompact, ICMSsystem, ICMcompact, or ICMmonitor.

The sensor fixture SFX1 is suited to secure the acoustic sensors on a GIS. The magnetic sensor fixtures SFX2 and the sucking fixture SFX3 are for temporary mounting of the acoustic sensors on a transformer tank.



## EXTERNAL RETROFIT UHF SENSORS FOR GIS

### Window sensor WS80/95/140

External window sensors are used to conveniently equip older GIS with UHF monitoring. Power Diagnostix offers such window sensors of different sizes to fit the inspection windows of older GIS. Here, the obtained results with sensitivity are comparable to embedded sensors, if the window has a diameter of 80 mm or higher. In case well matched, such external window sensors offer a sensitivity of few pC.

### External flange sensor EFS1

The external flange sensor EFS1 is a wide-band UHF antenna for PD detection on GIS and GIL. Since it is wrapped round the unshielded flange connection, the flange dimensions are required on order. With the N-connector it can be directly jointed with a UHF preamplifier like the UHF1 and UHF2 or the pre-acquisition unit FCU2. Power Diagnostix offers two different models, for permanent and for temporary installation.

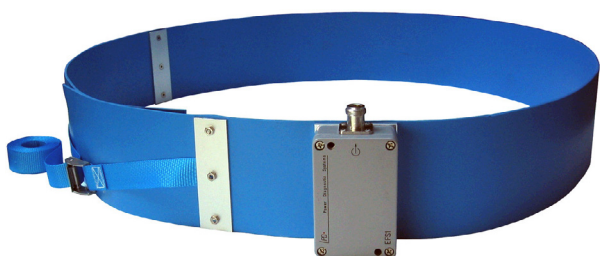

## UHF TRANSFORMER SENSORS

### Valve sensor TVS2 and flange sensor TFS1

UHF transformer sensors can be used to detect internal PD on power transformers in a frequency range between 300 MHz and 1 GHz. The UHF frequency range can be chosen under difficult on-site conditions, such as high impact of the measurements due to corona discharges or other disturbances within the typical HF range (100 kHz to 10 MHz). UHF sensors are suitable for retrofitting as well as for pre-installation. The sensitivity can be proven by injecting an impulse generator signal in the UHF range into the system. UHF PD signals can be used for PD pattern analysis as well as for triggering acoustic measurement systems, like the FOS4, for instance. Power Diagnostix provides the TFS1 for valve flanges and the TVS2 for oil valves. Both sensors can be modified and designed in accordance of special customer specifications.



## CABLE SENSORS

### Differential foil sensor DFS1

Besides the embedded coaxial sensor of cable accessories, external sensors can be applied to joints and terminations. Especially on cross-bonding joints differential foil sensors serve to capture partial discharge signals in elevated frequencies. Such foil sensors can be permanently installed for monitoring or temporarily applied for survey type measurements.





## PD accessories

# Quadrupoles and isolation transformers

### QUADRUPOLES

When a quadrupole and a coupling capacitor are used together as the coupling device, high voltage is applied both to a test object and to the coupling capacitor in parallel with the test object. A quadrupole (sometimes called a measuring impedance) can then be placed in series with either the coupling capacitor or in series with the test object. Some quadrupoles also output a low-voltage copy of the applied high voltage wave for synchronizing the PD detector. The three basic models of available Power Diagnostix quadrupoles are briefly described here.

#### CIL quadrupoles

The CIL quadrupoles consist of an inductor in parallel with a damping resistor. The inductor and resistor are calculated to form, together with a high voltage coupling capacitor, a second order high pass filter. Therefore, matching the range of the CIL with the size of the coupling capacitor with which it will be used is important.

#### CIT quadrupoles

The CIT coupling units are transformer type units, where a preamplifier's input resistance functions as the required damping resistor. CIT units offer a higher sensitivity than the CIL coupling units. Furthermore, CIT units are available for bridged configurations to connect to two similar test objects as well.

#### CIL/V and CIT/V quadrupoles

The CIL/V and CIT/V quadrupoles are similar to the CIL and CIT quadrupoles but also contain at least one built-in capacitor acting as a voltage divider together with the high voltage coupling capacitor. This provides a low-voltage copy of the applied high voltage wave that can be used through an HST to synchronise the PD detector and monitor the quality of the applied high voltage wave.

Optionally, Power Diagnostix quadrupoles can be equipped with multiple built-in divider capacitors for voltage measurement. Those quadrupoles have a rotary switch to select the



Assorted quadrupoles

required divider capacitor. Especially, when connected to the measurement tap of transformer bushings, the selectable capacitors expand the applicable voltage range.

TYPE	COUPLING CAPACITOR RANGE	MAX. AC CURRENT
CIL1H	20 pF to 90 pF	50 mA
CIL2H	60 pF to 250 pF	100 mA
CIL3L	200 pF to 900 pF	50 mA
CIL3M	200 pF to 900 pF	200 mA
CIL3H	200 pF to 900 pF	500 mA
CIL4L	600 pF to 2.5 nF	100 mA
CIL4M	600 pF to 2.5 nF	400 mA
CIL4H	600 pF to 2.5 nF	1100 mA
CIL5L	2 nF to 9 nF	400 mA
CIL5M	2 nF to 9 nF	1600 mA
CIL5H	2 nF to 9 nF	3200 mA
CIL6L	6 nF to 25 nF	1000 mA
CIT4M	600 pF to 2.5 nF	400 mA
CIT4H	600 pF to 2.5 nF	1100 mA
CIT5M	2 nF to 9 nF	1600 mA
CIT5H	2 nF to 9 nF	3200 mA
CIT6M	6 nF to 25 nF	4000 mA
CIT6H	6 nF to 25 nF	8000 mA

### ISOLATION TRANSFORMERS

The IT series allows the permanent isolation of 250 Volts between input and output. Its high frequency behaviour is optimised for 50  $\Omega$  systems and the use with a multiplexer and RPA2 or RPA2B type of preamplifier. An extra voltage output 'V' with the 50/60 Hz fundamental frequency is available on request.



## PD accessories Coupling capacitors

### COUPLING CAPACITORS

Analysing the discharge activity requires the permanent installation of coupling devices. Preferably, such coupling devices are capacitive couplers terminated by a power separation filter.



*Coupling capacitors for permanent installation*

Power Diagnostix's coupling capacitors for permanent installation are suitable for partial discharge testing and monitoring of high voltage assets such as:

- Medium voltage motors
- Turbine generators
- Hydro generators
- Distribution transformers

while the coupling capacitors for temporary installation are mainly used in laboratories and workshops for PD testing of:

- Rotating machines of various types
- Power transformers
- Medium voltage switchgears

as well as for a variety of smaller test setups.

The built-in quadrupole of the couplers provides a PD signal and a superimposed AC component for synchronisation purposes.



*Coupling capacitors for temporary installation*

TYPE	CAPACITANCE	NOM. VOLTAGE	BUILT-IN QUADRU-POLE	BUILT-IN VOLTAGE DIVIDER	BUILT-IN RF CT
CC5B/V	2 nF	5 kV	●	●	
CC7B	440 pF	7 kV	●	●	
CC14B	220 pF	14 kV	●	●	
CC15B/V	2 nF	15 kV	●	●	
CC20B	145 pF	20 kV	●	●	
CC25B	1 nF	25 kV	●	●	
CC25B/V	1 nF	25 kV	●	●	
CC25C/V	1 nF	25 kV	●	●	●
CC35B/V	145 pF	35 kV	●	●	
CC50B/V	1 nF	50 kV	●	●	
CC50C/V	1 nF	50 kV	●	●	●
CC100B/V	1 nF	100 kV	●	●	
CC150B/V	1 nF	150 kV	●	●	
CC200B/V	0.5 nF	200 kV	●	●	
CC300B/V	0.5 nF	300 kV	●	●	

A wider range of coupling capacitors and capacitor assemblies completed by quadrupoles and preamplifiers is available on request. The table above lists some standard models of coupling capacitors provided by Power Diagnostix, along with their built-in circuits, if present.

### COUPLER TERMINATION BOXES

A coupler termination box is necessary for providing the protective ground for the coupler's BNC signal cable.

- Sturdy cast aluminium enclosure
- Output connectors protected by chained caps
- Built-in overvoltage protection



TYPE	CHANNELS	SPARK GAP	IN	OUT
CTB1A	3	350 V	BNC	BNC
CTB1C	3	350 V	TNC	BNC
CTB2A	4	350 V	BNC	BNC
CTB2C	4	350 V	TNC	BNC



## PD accessories

# Preamplifiers and pre-acquisition units

### PREAMPLIFIERS AND PREACQUISITION UNITS

Power Diagnostix provides a complete line of modular preamplifiers and pre-acquisition units for various testing applications. The most significant difference among the preamplifiers is the frequency range in which they detect partial discharge signals. Other features that distinguish one preamplifier from another are: options for transparency and on/off switching, unipolar vs. bipolar charge detection, and the possibility of galvanic isolation in the test setup.

All of the Power Diagnostix external signal conditioning modules and preamplifiers are remote supplied and remote controlled through a simple coaxial signal cable (RG58). This technique allows placement of these units close to the sensor or signal source. Furthermore, as these modules act as impedance converter and line driver, the weak signal source, such as voltage divider or coupling impedance, is not loaded by the cable capacitance or impedance.

This technique also provides enhanced overvoltage protection. All preamplifiers of the RPA series can drive a 50 W cable with a length of up to 50 m.

The RPA1 is the standard preamplifier for measurements in the low frequency range according to standards, such as the IEC 60270. The RPA1D, RPA1E, RPA1F, and RPA1G are variations on the RPA1.

The RPA1D and RPA1G are suited to connect directly to ultrasonic acoustic sensors. To simplify connection, they provide the selectable power supply for the sensor (15 V or 28 V DC).

The RPA1L and RPA1H are intended primarily for measurements on medium- and high voltage power cables using the ICMcompact.

The RPA2 is primarily for measuring the PD signal spectra found with rotating machines, while the RPA2B is used with capacitive sensors to monitor cables and cable accessories at a higher sensitivity.

The RPA3 module is well-suited for measuring PD signal spectra, detected by sensors and antennas installed with gas insulated switchgear (GIS).

The RPA4 is a preamplifier set with fibre optic transmission, offering outstanding isolation properties.

The frequency converter unit FCU2 is an ultra-wide band pre-acquisition unit, covering 100 to 1800 MHz. It has a logarithmic output and is mainly used for GIS applications.

The UHF1 and UHF2 offer an amplification of 27 dB in the range from 200 MHz to 1 GHz resp. 300 MHz to 2 GHz, and are suitable for boosting weak signals from GIS sensors.

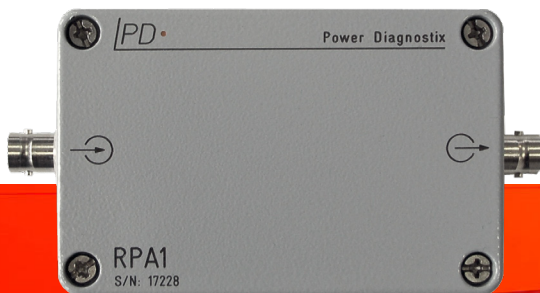

**Get detailed information on accessories with our separ**

## PD accessories

### Preamplifiers and pre-acquisition units

TYPE	FREQUENCY RANGE	INPUT IMPEDANCE	SENSITIVITY INPUT	ROLL-OFF	BIPOLAR	REMARKS
RPA1	40 kHz to 800 kHz	10 k $\Omega$ //50 pF	<200 $\mu$ V	40dB/dec	Yes	Standard preamplifier
RPA1D	40 kHz to 800 kHz	10 k $\Omega$ //50 pF	<200 $\mu$ V	40dB/dec	Yes	Built-in sensor supply, switchable (15/28 V)
RPA1E	40 kHz to 800 kHz	10 k $\Omega$ //50 pF	<200 $\mu$ V	40dB/dec	Yes	0/20 dB attenuation
RPA1F	40 kHz to 800 kHz	10 k $\Omega$ //50 pF	<200 $\mu$ V	40dB/dec	Yes	For the AICompact only
RPA1G	40 kHz to 800 kHz	10 k $\Omega$ //50 pF	<200 $\mu$ V	40dB/dec	Yes	Built-in sensor supply, switchable (Off/15/28 V)
RPA1H	40 kHz to 20 MHz	1 k $\Omega$ //50 pF	<400 $\mu$ V	40dB/dec	Yes	Oil/paper cable, DSO
RPA1L	40 kHz to 20 MHz	1 k $\Omega$ //50 pF	<200 $\mu$ V	40dB/dec	Yes	Cable, DSO
RPA2	2 MHz to 20 MHz	50 $\Omega$ //50 pF	<800 $\mu$ V	40dB/dec	No	On-line measurements on rotating machines
RPA2B	2 MHz to 20 MHz	50 $\Omega$ //50 pF	<200 $\mu$ V	40dB/dec	No	Cable sensors
RPA3	200 MHz to 1 GHz	50 $\Omega$ //50 pF	<300 $\mu$ V	40dB/dec	No	GIS sensors
RPA3D	50 MHz to 400 MHz	50 $\Omega$ //50 pF	<300 $\mu$ V	40dB/dec	No	Nearfield detection
RPA3E	20 MHz to 200 MHz	50 $\Omega$ //50 pF	<300 $\mu$ V	40dB/dec	No	Nearfield detection
RPA4	40 kHz to 800 kHz	10 k $\Omega$ //50 pF	<200 $\mu$ V	40dB/dec	Yes	Fibre optic isolation
FCU2	100 MHz to 1.8 GHz	50 $\Omega$ //50 pF	<200 $\mu$ V	40dB/dec	No	Logarithmic output
FCU2A	1 GHz to 2 GHz	50 $\Omega$ //50 pF	<200 $\mu$ V	40dB/dec	No	Logarithmic output
FCU2B	100 MHz to 1 GHz	50 $\Omega$ //50 pF	<200 $\mu$ V	40dB/dec	No	Logarithmic output
FCU3	100 kHz to 50 MHz	50 $\Omega$ //50 pF	<200 $\mu$ V	40dB/dec	No	Logarithmic output, cable sensors
UHF1	200 MHz to 1 GHz	50 $\Omega$ //50 pF	–	–	No	GIS sensors
UHF2	300 MHz to 2 GHz	50 $\Omega$ //50 pF	–	–	No	GIS sensors

**Power Diagnostix's range of  
ate accessories catalogue.**



# PD accessories

## Current transformers

### CURRENT TRANSFORMERS

Current transformers (CT) are a low-impact option for sensing partial discharge pulses and sending them as voltage signals to a preamplifier or a pre-processing unit for conditioning. No interruption of the power connection is required. The installation of a CT is even possible under on-line conditions, since most of Power Diagnostix' current transformers can be opened and reassembled or clamped around an already existing connection.

Providing a galvanic isolation between the PD detector or PD on-line monitoring system and the high voltage circuit a current transformer reduces the risk of unwanted damages on the sensitive measurement equipment.

Power Diagnostix current transformers are versatile and suitable for many different test setups. They that can be used with:

- Connecting cables
- Cross link cable boxes
- Cross link box busbars
- Ground leads
- Medium voltage cables
- Coupling capacitor terminals

TYPE	TRANSF. RATIO AT 50 Ω	PRIMARY WINDOW	BANDWIDTH AT -3 DB	BANDWIDTH AT -6 DB
CT1	1:10	15 mm	0.5 to 80 MHz	0.3 to 100 MHz
CT40R	1:10	40 mm	2 to 25 MHz	1.2 to 40 MHz
CT50/10	1:10	50x10 mm	2 to 90 MHz	1.7 to 93 MHz
CT60R	1:10	60 mm	2 to 25 MHz	1.2 to 40 MHz
CT100(R)	1:10	100 mm	2 to 25 MHz	1.2 to 40 MHz
CT125R	1:10	125 mm	2 to 25 MHz	1.2 to 40 MHz
CT150R	1:10	150 mm	2 to 25 MHz	1.2 to 40 MHz

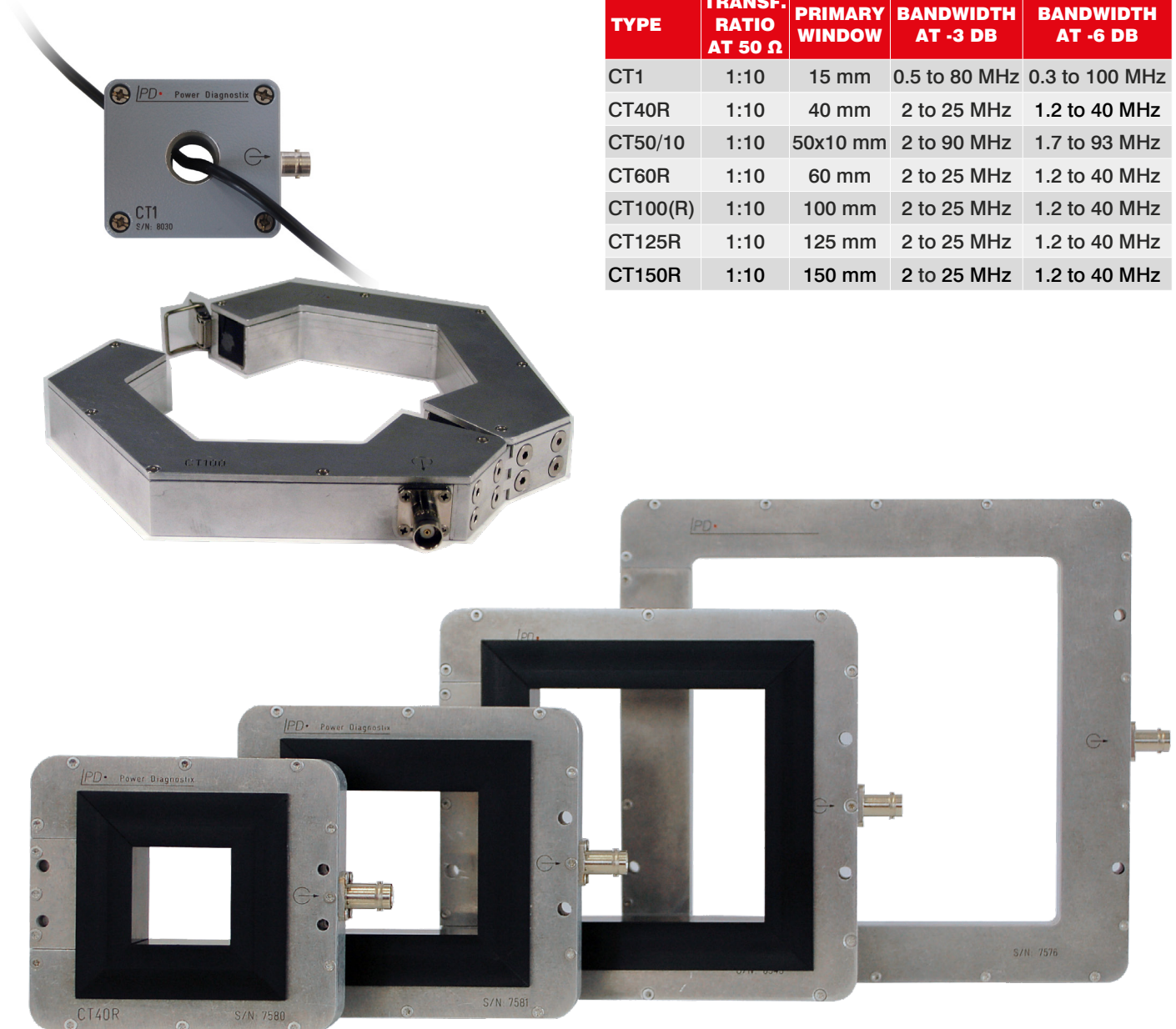

Current transformers of the CTR series



# PD accessories Bushing accessories

## BUSHING COUPLING UNITS

The bushing coupling units are for permanent installation on power transformers. Together with a matching bushing adapter they serve to make different signals available for measurement and monitoring. The bandwidth of the partial discharge signals extends to 20 MHz. The voltage signal of the built-in capacitive divider serves to synchronise the partial discharge acquisition and to measure the voltage. However, the excellent bandwidth of the voltage signal also allows transfer impedance measurements and loss factor measurements. The bushing coupling unit comes in a IP66 protected enclosure with a PTFE insulated input cable. Thus, it is suitable for indoor and outdoor use. The voltage range and bushing capacitances (C1 and C2) have to be specified on order.



BCU2D

## BUSHING ADAPTERS

TYPE	THREAD	SIZE	CONNECTOR	SIZE	DIMENSIONS	WEIGHT
BA2	inside	G3/4"	female	4 mm	Ø50 x 64 mm	170 g
BA3	outside	M45x2	female	8 mm	Ø65 x 118 mm	1 kg
BA4 adapt.	flange inside	-- M76x1,5	male	8 mm	□70 x 103 mm	400 g
BA5	inside	M24	male	4 mm	□41 x 79 mm	200 g
BA6	outside	M38x1,5	male	4 mm	Ø44 x 80 mm	190 g
BA7C	outside	2 1/4"-12 UNF	female	8 mm	Ø80 x 104 mm	190 g
BA7D	outside	2 1/4"-12 UNF	female	3.5 mm	Ø80 x 104 mm	190 g
BA8	inside	5/8"-11 UNC	--	3 mm	□30 x 70 mm	100 g
BA9	outside	M30x1,5	female	4 mm	Ø50 x 60 mm	180 g
BA9B	inside	M30x1,5	female	8 mm	Ø50 x 66 mm	180 g
BA10	outside	M16x1,5	female	4 mm	Ø55 x 64 mm	120 g
BA10B	outside	M16x1,5	female	4 mm	Ø34 x 64 mm	90 g
BA10C	outside	M16x1,5	female	4 mm	Ø25 x 61 mm	60 g
BA11	flange		female	8 mm	□85 x 100 mm	500 g
BA12	outside	M30x2	female	6 mm	Ø45 x 87 mm	200 g
BA14	outside	1 1/16"-12 UN	female	8 mm	Ø45 x 100 mm	210 g
BA15	outside	M30x2	female	9 mm	Ø45 x 102 mm	200 g
BA17	outside	M30x2	female	4 mm	Ø40 x 82 mm	190 g
BA18	flange	--	female	8 mm	41 x 72 x 127 mm	180 g
BA19	flange	--	female	8 mm	□82 x 105 mm	1 kg
BA21	outside	M24x1.5	female	4 mm	Ø50 x 71 mm	180 g
BA21B	outside	M24x1.5	female	4 mm	Ø50 x 71 mm	180 g
BA23	inside	M36x3	female	5 mm	Ø40 x 59 mm	180 g
BA25	outside	1 1/4"-12 UNF	spring	5 mm	Ø45 x 60 mm	140 g
BA26	outside	1 1/8"-12 UNF	female	1/4"	Ø50 x 60 mm	150 g
BA27	outside	1 1/8"-12 UNF	female	8 mm	Ø45 x 70 mm	150 g
BA28	outside	3/4"-14 NPSM	spring	9 mm	Ø34 x 56 mm	80 g
BA29	inside	M33x1.5	female	4 mm	Ø43 x 62 mm	330 g
BA30	inside	M30x1.5	female	6 mm	Ø44 x 61 mm	150 g
BA31	inside	4x6 holes, dist.: 44 mm	female	10 mm	□58 x 53 mm	100 g
BA32	inside	M42x1.5	female	6 mm	Ø49 x 76 mm	400 g
BA33	outside	M20x1.5	male	5.3 mm	Ø44 x 59 mm	150 g
BA34	inside	M20x1.5	male (adapter)	M6	Ø43 x 91 mm	350 g



# PD accessories

## Filters

### HV FILTERS

Partial discharge measurements are conducted in frequency ranges, which are partly covered by radio transmission. Further, impulse noise interference hamper sensitive measurements. Besides using small filters in the acquisition chain, power filters allow removing such disturbance from the high voltage supply. Power Diagnostix offers a range of different high voltage filters.

Pi-Filters are for three-phase systems up to 2 kV, whereas the single-phase T-filters are used for testing with higher voltages.



Filter T100/100

Those filters are installed in-line between voltage source and device under test.

The typical frequency range of Power Diagnostix HV filters is 0 to 300 Hz. For a short time they can be operated with frequencies up to 400 Hz.

For gating purposes, filters that are used in combination with an ICMflex can be equipped with a high frequency current transformer (HF CT) and a BNC output.

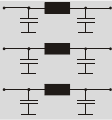
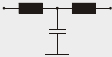
TYPE	NAME	$U_{N,rms}$	$I_{N,rms}$	SIZE IN MM (W X H X D)	
3π-Filters	 3PI1/20	1 kV	20 A	400 x 170 x 460	
	3PI1/50	1 kV	50 A	400 x 170 x 460	
	3PI2/20	2 kV	20 A	400 x 170 x 460	
T-Filters		T30/1	30 kV	1 A	357 x 620 x 357
		T30/5	30 kV	5 A	357 x 620 x 357
		T30/20	30 kV	20 A	357 x 620 x 357
		T30/100	30 kV	100 A	507 x 620 x 357
		T50/1	50 kV	1 A	357 x 800 x 357
		T50/5	50 kV	5 A	357 x 800 x 357
		T50/20	50 kV	20 A	357 x 800 x 357
		T50/100	50 kV	100 A	500 x 800 x 450
		T100/1	100 kV	1 A	357 x 1000 x 357
		T100/5	100 kV	5 A	357 x 1000 x 357
		T100/20	100 kV	20 A	357 x 1000 x 357
T100/100	100 kV	100 A	507 x 1000 x 457		

HV filters of different ratings ( $U_N$ ,  $I_N$ ) are available on request.

### GROUND FILTER

Partial discharge (PD) measurement requires a reasonable noise-free environment. Power Diagnostix's GF50 filter box is designed to reduce high frequent disturbance signals from the ground leads. It can be used for HF separation of the test specimen from the ground potential of the power supply or other HV equipment within the environment without influencing the power frequency. The efficiency strongly depends on the

general earthing within the laboratory. A splitted ground lead or copper band can be connected to the multi contact connectors or alternatively to the wing screws beside.

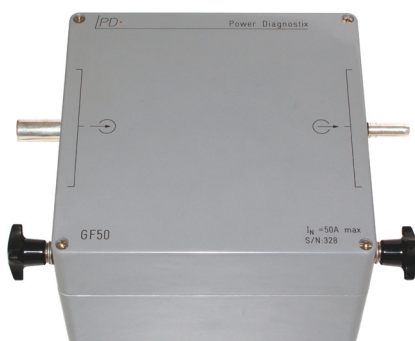

### FILTER MODELS FOR SPECIAL APPLICATIONS

Besides the standard HV filters, Power Diagnostix offers various filters for special high voltage applications, including line filters for cable testing (such as the LF15 and LF350) and filters with AC current and AC voltage measurement.

With the latter a high voltage filter is combined with a high voltage divider and a high current transformer in one unit; conventionally on rolls, or upside-down, as shown.





### DISTURBANCE ANTENNAS

The disturbance antenna DA1 can be used to pick up noise signals caused by local corona discharge, or AM radio waves for instance. Its magnetic holder allows a flexible placement on a transformer tank or to other metallic parts close to the object under test. The output signal can be used to trigger the gate input circuit of all PD acquisition or monitoring devices.



DA1 disturbance antenna

The wideband antenna DA2 consists of a UHF antenna and a frequency converter unit. It is designed to filter HF signals, e.g., emitted by GSM transmitting antennas. Therefore it is especially used for GIS monitoring.

### DISCHARGE RADIATION ANTENNA

With its built-in wide band logarithmic amplifier this antenna is suitable for the detection of discharge signals on air insulated switchgear (AIS) cabinets. It consists of a VHF antenna and a magnetic holder for simple fixture on visual inspection holes on metal housings.

### GATE SIGNAL TRANSMITTER



The gate signal transmitter GST1 converts TTL or analogue gate signals into a fibre optic TTL output signal. It has a logarithmic amplification and can be set to three different frequency ranges (40 to 800 kHz, 2 to 20 MHz, or 200 to 600 MHz), which can be selected with a push button. The active bandwidth mode is marked by a lit green LED. The trigger level can be adjusted by a rotary knob, while an LED bargraph indicates the actual signal strength.

### ACTIVE BRIDGE ADAPTER

The active bridge adapter is an optional accessory that can be used in certain circumstances to 'subtract' noise from the measurement setup.

The active bridge adapter AB1 serves to balance the signal picked up by two preamplifiers to reduce the common mode noise or disturbance. This method is applicable when two branches are available.

A mismatch of the signal strength can be adjusted with the AB1's control knob. With the preamplifiers of the two branches connected to the 'Pos' and 'Neg' input of the AB1, and the output connected to the AMP IN of the PD detector, the control knob is used to minimise the common mode signal.



AB1

### INPUT PROTECTION UNITS

The protection units are designed to avoid damage of spectrum analyser input circuits or of preamplifier input stages under the presence of strong transient signals.

They are available for indoor application (IP52 protection) and for outdoor use (IP65 protection).

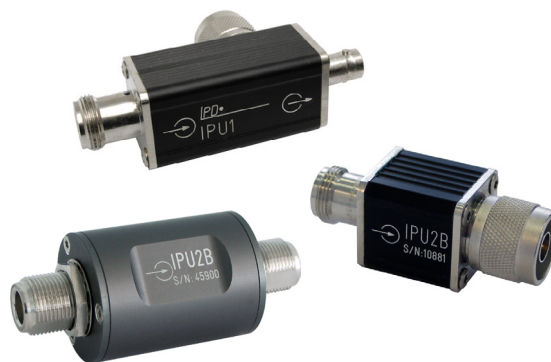

### SIGNAL COMBINER

The CSC1 allows to select or combine signals from four BNC inputs to one BNC output. The input and output impedance is thereby kept to 50 W, even if one channel is selected or if the sum of all four channels is selected.

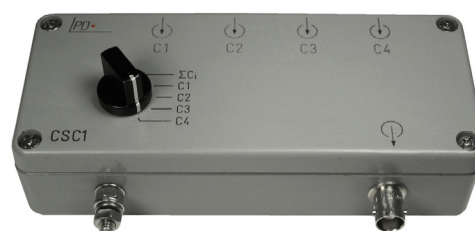

CSC1

# PD accessories

## Miscellaneous

### HIGH VOLTAGE TRANSFORMERS

Power Diagnostix offers miscellaneous transformers as voltage source for testing purposes. Depending on the customer's needs and the specific testing application Power Diagnostix high voltage transformers cover a voltage range up to 300 kV. Please contact us for detailed information.

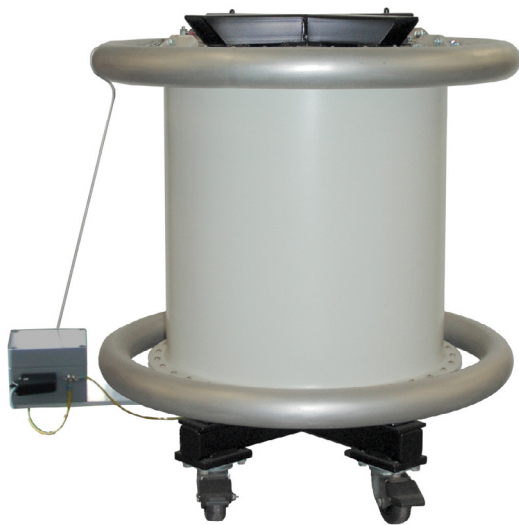

*HV transformer HVT100/11*

### TRANSPORTATION CASE FOR INSTRUMENTS OF THE ICM SERIES

All instruments of the ICM series can be delivered with a solid transport case made of high performance plastic compound with customised cut-out foam. It allows for the safe handling and transportation of one instrument and its accessories.

The cases are water and dust tight according to Ingres protection class IP 67.



## ICMexpert

ICMexpert is a database software for managing partial discharge (PD) patterns and extends the possibilities of Power Diagnostix programs like ICMcompact, ICMmonitor, ICMsystem, HVPilot, ICMflex, and GISmonitor. This easy-to-use tool offers functions for three main tasks occurring regularly when doing PD measurements:

- Classification of pattern according to their PD fault(s)
- Pattern editing to correct deficiencies of the set-up, erase disturbances, and highlighting pattern regions characterizing typical PD faults
- Adding and maintaining additional information to recorded pattern

For each of these tasks ICMexpert provides a separate software panel.

The database structure is customizable according to different applications and user requirements. Additionally, the ICMexpert software supports the export of complete clones or parts of the database. Clones can be used to operate with the same database structure on different computers staying compatible with each of the used database files.

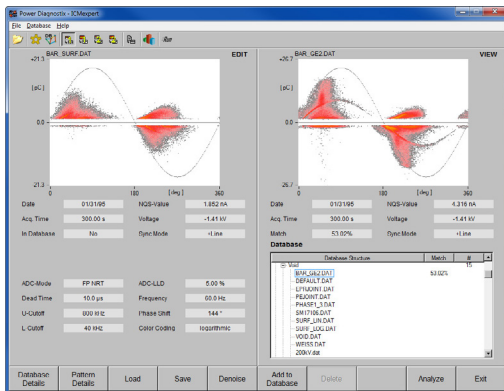

ICMexpert database overview panel

## ICMacoustic

For PD location purposes the ICMacoustic software offers simple and full control of the FOsystem FOS4 or an oscilloscope of the Tektronix 20xx family. The software provides a virtual instrument to run the FOS4 or the oscilloscope under Windows 7, 8, and 10 (32-bit). Critical frequencies can easily be detected and filters can be set for in-depth analysis.

Contained functions are:

- Simultaneous display of up to 12 channels of the FOS4
- Accurate fault location by triangulation with freely configurable parameters for the different propagation velocities in oil and steel

- Screenshot functions
- Analysis and visualisation of measurement results through customizable 3D models
- Extensive report and export functions for measuring results and graphical representation of the fault location
- Convenient step-by-step wizard during the measurement

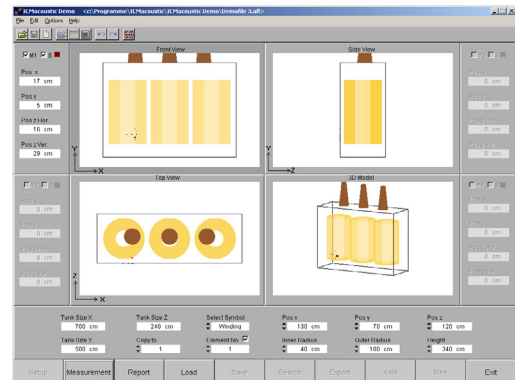

ICMacoustic software, analysis panel

## ICMreport

ICMreport is a program for quick and easy creation of reports for insulation measurements on high voltage equipment. The software can process data files resulting from programs, such as ICMmonitor, ICMsystem, AIAcompact, ICMcompact, and GISmonitor. These can be simply dragged and dropped into the report document. Thus, no programming knowledge is required for report generation.

Key features are:

- Print function and PDF export
- Convenient report creation with templates
- Drag and drop of imported and graphically processed data into a Word document
- One-click functionality for simple reports
- Export of partial discharge (PD) patterns as image files or by drag and drop into external applications

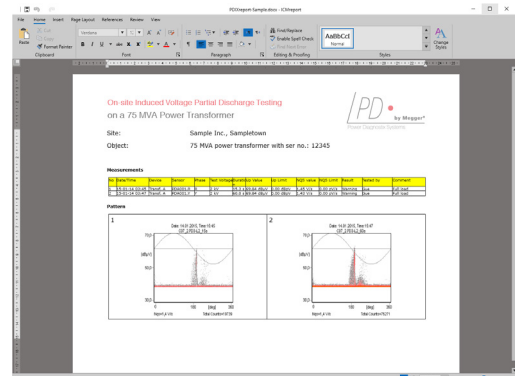

ICMreport, report generation panel



## Services

# Our knowledge for your benefit

Power Diagnostix provides various services, such as on-site measurements, commissioning tests, DAkkS calibration of instruments, installation of couplers and monitoring systems, as well as rental of test equipment. Additionally, Power Diagnostix acts as a consultant to analyse defect mechanism or to improve high voltage insulation systems, for instance.

### CONSULTING

Power Diagnostix assists to analyse encountered defects, failure mechanism, and helps to improve insulation systems. Further, support is provided to implement monitoring systems and to integrate embedded partial discharge sensors into insulation systems. Additionally, Power Diagnostix offers interpretation service for partial discharge pattern acquired by local testing groups. Instruments equipped with modem or our mobile web server MWS1 also allow Power Diagnostix having remote access for performing measurements and diagnosis.

### ON-SITE MEASUREMENTS

Power Diagnostix engineers are available on short notice for on-site partial discharge measurements. Such on-site measurements cover on-line and off-line diagnostics on rotating machines including large motors, partial discharge mapping on cable systems, survey-type measurements on gas-insulated substation equipment, and partial discharge acceptance testing and PD location on large transmission-class power transformers. All required instruments are provided, of course. VLF sources and smaller high voltage sources can be provided as well. However, rental of larger test sets needs to be subcontracted.



### RENTAL OF EQUIPMENT

Generally, Power Diagnostix testing equipment is available for rental or leasing, if budget constraints do not allow an investment, for instance.

### CALIBRATION SERVICE

Power Diagnostix operates a calibration laboratory, which has received the accreditation within the German Calibration Service DKD by 2003. In January 2012, Power Diagnostix passed to the newly introduced German accreditation authority DAkkS (DAkkS = **D**eutsche **A**kkreditierungs**s**telle). The audit according to ISO 17025:2018 was held by 'Physikalisch Technische Bundesanstalt' (PTB), the German authority of standards. Power Diagnostix's new accreditation is filed under D-K-15068-01-00. The accreditation covers impulse charge (pC), voltages, and timing parameters, as well as on-site calibration of voltages up to 100 kV AC.

The DAkkS calibration service is of course also available for instruments and calibrators of other vendors.



*HV labs at our facilities in Aachen*

### SEMINARS AND TRAINING

Standard shop-floor partial discharge testing is a comparable easy task. However, applying in-depth partial discharge diagnostics requires knowledge and experience. Here, Power Diagnostix assists with training sessions for testing and engineering personnel and with seminars for larger service groups. Besides the mere installation and usage of the instruments, emphasis is put on understanding the theoretical background of partial discharge pattern, defect mechanism, and the interpretation of measurement results.

### INSTALLATION SERVICE

Especially for monitoring systems a complete installation service is offered. Typically, this installation of couplers and instruments include the calibration of the entire setup and the base-line measurement.







Power Diagnostix Systems GmbH  
Vaalser Strasse 250, 52074 Aachen, Germany  
Tel. +49 241 74927, Fax. +49 241 79521  
E-Mail: support(at)pdix.com

**[www.pdix.com](http://www.pdix.com) | [www.megger.com](http://www.megger.com)**

We reserve the right to make technical changes. [PDIX\\_Catalogue\\_EN\\_v20](#)  
The word 'Megger' is a registered trademark. Copyright © 2024

**PD** ●  
**by Megger®**  
Power Diagnostix Systems